



Dell™ Dimension™ 4500S

Owner's Manual



www.dell.com | support.dell.com

Hints, Notices, and Cautions

-  **HINT:** A HINT indicates important information that helps you make better use of your computer.
-  **NOTICE:** A NOTICE indicates either potential damage to hardware or loss of data and tells you how to avoid the problem.
-  **CAUTION:** A CAUTION indicates a potential for property damage, personal injury, or death.

Abbreviations and Acronyms

For a complete list of abbreviations and acronyms, see the *Tell Me How* help file. To access help files, see page 26.

**Information in this document is subject to change without notice.
© 2002 Dell Computer Corporation. All rights reserved.**

Reproduction in any manner whatsoever without the written permission of Dell Computer Corporation is strictly forbidden.

Trademarks used in this text: *Dell*, the *DELL* logo, *Dimension*, *Inspiron*, *Latitude*, *OptiPlex*, *Dell Precision*, *DellPlus*, and *DellNet* are trademarks of Dell Computer Corporation; *EMC* is the registered trademark of EMC Corporation; *Intel*, *Celeron*, and *Pentium* are registered trademarks of Intel Corporation; *Microsoft* and *Windows* are registered trademarks of Microsoft Corporation.

Other trademarks and trade names may be used in this document to refer to either the entities claiming the marks and names or their products. Dell Computer Corporation disclaims any proprietary interest in trademarks and trade names other than its own.

This product incorporates copyright protection technology that is protected by method claims of certain U.S. patents and other intellectual property rights owned by Macrovision Corporation and other rights owners. Use of this copyright protection technology must be authorized by Macrovision Corporation, and is intended for home and other limited viewing uses only unless otherwise authorized by Macrovision Corporation. Reverse engineering or disassembly is prohibited.

April 2002 P/N 7M291 Rev. A00

Contents

Safety Instructions	7
When Using Your Computer	7
When Working Inside Your Computer	9
Protecting Against Electrostatic Discharge	10
Battery Disposal	10
Finding Information for Your Computer	11

1 Setting Up

Attaching and Removing the Computer Stand	16
Connecting a Printer	18
Parallel Printer	18
USB Printer	19
Installing the Printer Driver	19
Transferring Information to a New Computer	20
Setting Up a Home and Office Network	21
Connecting to a Network Adapter	21
Network Setup Wizard	21
Turning Off the Computer	22

2 Solving Problems

Finding Solutions	24
Finding Help Information	26
Battery Problems	26

Drive Problems	27
Floppy drive problems	27
CD drive problems	28
Problems writing to a CD-RW drive	29
DVD drive problems	29
Hard drive problems	29
E-Mail, Modem, and Internet Problems	30
Error Messages	31
General Problems	33
The computer stops responding	33
A program stops responding	33
A program crashes repeatedly	33
A program is designed for an earlier Windows operating system	33
A solid blue screen appears	34
Other software problems	34
Other technical problems	35
General hardware problems	35
Keyboard Problems	36
Mouse Problems	37
Network Problems	38
Power Problems	39
Printer Problems	41
Scanner Problems	42
Sound and Speaker Problems	43
No sound from speakers	43
No sound from headphones	44
Video and Monitor Problems	44
If the screen is blank	44
If the screen is difficult to read	45

3 Advanced Troubleshooting

Diagnostic Lights	48
Using System Restore	50
Creating a Restore Point	50
Restoring the Computer to an Earlier Operating State	51
Undoing the Last System Restore	52
Reinstalling Drivers	53
Using Windows® XP Device Driver Rollback	53
Using the Dell Dimension ResourceCD	53
Resolving Software and Hardware Incompatibilities	54
Reinstalling Windows® XP	55

4 Adding Parts

Front and Back View of the Computer	60
Front View	60
Back View	61
Opening the Computer Cover	62
Looking Inside Your Computer	64
System Board	65
Adding Cards	66
Adding Memory	70
Removing a Memory Module	71
Adding a Memory Module	71
Closing the Computer Cover	72

5 Appendix

Specifications	74
Standard Settings	78
Viewing Settings	79
System Setup Program Screens	79
Clearing Forgotten Passwords	80
Replacing the Battery	81
Dell Technical Support Policy (U.S. Only)	83
Definition of "Dell-Installed" Software and Peripherals	83
Definition of "Third-Party" Software and Peripherals	84
Contacting Dell	84
Contact Numbers and Addresses	84
Returning Items for Warranty Repair or Credit	99
Regulatory Information	99
FCC Notices (U.S. Only)	101
NOM Information (Mexico Only)	103
Limited Warranties and Return Policy	104
One-Year Limited Warranty (U.S. Only)	104
Two-Year Limited Warranty (U.S. Only)	106
Three-Year Limited Warranty (U.S. Only)	110
Four-Year Limited Warranty (U.S. Only)	113
One-Year Limited Warranty (Canada Only)	116
Two-Year Limited Warranty (Canada Only)	118
Three-Year Limited Warranty (Canada Only)	121
"Total Satisfaction" Return Policy (U.S. Only)	125
One-Year End-User Manufacturer Guarantee (Latin America and the Caribbean Only)	126

Index	129
------------------------	------------

Safety Instructions

Use the following safety guidelines to help protect your computer from potential damage and to ensure your own personal safety.

When Using Your Computer

As you use your computer, observe the following safe-handling guidelines.

 **CAUTION: Do not operate your computer with any cover(s) (including the computer cover, filler brackets, front-panel inserts, and so on) removed or opened.**

- Your computer is equipped with one of the following:
 - A fixed-voltage power supply — Computers with a fixed-voltage power supply do not have a voltage selection switch on the back panel and operate at only one voltage (see the regulatory label on the outside of the computer for its operating voltage).
 - An auto-sensing voltage circuit — Computers with an auto-sensing voltage circuit do not have a voltage selection switch on the back panel and automatically detect the correct operating voltage.
 - A manual voltage selection switch — Computers with a voltage selection switch on the back panel must be manually set to operate at the correct operating voltage.
- To help avoid damaging a computer with a manual voltage selection switch, be sure that the voltage selection switch is set to match the AC power available at your location:
 - 115 V/60 Hz in most of North and South America and some Far Eastern countries such as South Korea and Taiwan
 - 100 V/50 Hz in eastern Japan and 100 V/60 Hz in western Japan

NOTE: The voltage selection switch must be set to the 115V position even though the AC supply in Japan is 100 V.

- 230 V/50 Hz in some regions in the Caribbean and South America and most of Europe, the Middle East, and the Far East

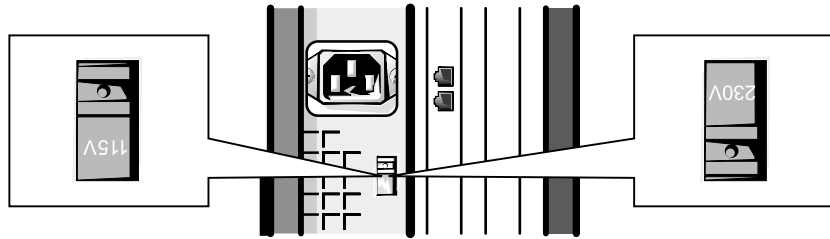

NOTE: Fixed-voltage power supplies and auto-select power supplies do not require a voltage selection switch. Your power supply may not have this switch. Check the regulatory label on the outside of the computer for your power supply type.

Also be sure that your monitor and attached devices are electrically rated to operate with the AC power available in your location.

- To avoid shorting out your computer when disconnecting a network cable, first unplug the cable from the network adapter on the back of your computer, and then from the network jack. When reconnecting a network cable to your computer, first plug the cable into the network jack, and then into the network adapter.
- To help avoid possible damage to the system board, wait 5 seconds after turning off the computer before disconnecting or connecting a non-USB device from the computer.
- To help prevent electric shock, plug the computer and device power cables into properly grounded power sources. These cables are equipped with three-prong plugs to help ensure proper grounding. Do not use adapter plugs or remove the grounding prong from a cable. If you must use an extension cable, use a three-wire cable with properly grounded plugs.



- To help protect your computer from sudden, transient increases and decreases in electrical power, use a surge suppressor, line conditioner, or uninterruptible power supply.
- Be sure that nothing rests on your computer's cables and that the cables are not located where they can be stepped on or tripped over.
- Do not spill food or liquids on your computer. If the computer gets wet, contact Dell (see page 84).
- Do not push any objects into the openings of your computer. Doing so can cause fire or electric shock by shorting out interior components.
- Keep your computer away from radiators and heat sources. Also, do not block cooling vents. Avoid placing loose papers underneath your computer; do not place your computer in a closed-in wall unit or on a bed, sofa, or rug.

When Working Inside Your Computer

Before you open the computer cover, perform the following steps in the sequence indicated.

 **CAUTION: Do not attempt to service the computer yourself, except as explained in this guide and elsewhere in Dell documentation. Always follow installation and service instructions closely.**

- 1 Perform an orderly computer shutdown using the operating system menu (see page 22).
- 2 Turn off your computer and any devices.
- 3 Ground yourself by touching an unpainted metal surface at the back of the computer before touching anything inside your computer.

While you work, periodically touch an unpainted metal surface on the computer to dissipate any static electricity that might harm internal components.

- 4 Disconnect any devices connected to the computer, including the monitor, from their electrical outlets to reduce the potential for personal injury or shock. Also, disconnect any telephone or telecommunication lines from the computer.
- 5 Disconnect the power cable to your computer, and then press the power button to ground the system board.

In addition, take note of these safety guidelines when appropriate:

- When you disconnect a cable, pull on its connector, not on the cable itself. As you pull connectors apart, keep them evenly aligned to avoid bending any pins. Also, before you connect a cable, make sure that both connectors are correctly oriented and aligned.
- Handle components and cards with care. Don't touch the components on a card. Hold a card by its edges or by its metal bracket.



CAUTION: There is a danger of a new battery exploding if it is incorrectly installed. Replace the battery only with the same or equivalent type recommended by the manufacturer. Discard used batteries according to the manufacturer's instructions.

Protecting Against Electrostatic Discharge

To prevent static damage, discharge static electricity from your body before you touch anything inside your computer and periodically while you work inside the computer. You can do so by touching an unpainted metal surface on the back of the computer.

You can also take the following steps to prevent static damage:

- Do not remove items from their antistatic packing material until you are ready to install them in your computer. Just before unwrapping the antistatic packaging, be sure to discharge static electricity from your body.
- When transporting a sensitive component, first place it in an antistatic container or packaging.

Battery Disposal

Your computer uses a lithium battery. For instructions about replacing the lithium battery in your computer, see page 81. The lithium battery is a long-life battery, and it is very possible that you will never need to replace it.

Do not dispose of the battery along with household waste. Contact your local waste disposal agency for the address of the nearest battery deposit site.



Finding Information for Your Computer

What Are You Looking For?

- A diagnostic program for my computer
- Drivers for my computer
- My computer documentation
- My device documentation

Find it Here

ResourceCD

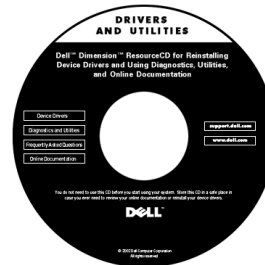

You can use this CD to access documentation and reinstall drivers (see page 53).

-
- How to set up a printer
 - How to troubleshoot and solve problems
 - How to add parts
 - How to contact Dell
 - Warranty information

Owner's Manual

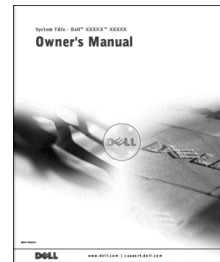

-
- Express Service Code and Service Tag Number
 - Windows License Label

Express Service Code and Windows License Label



Located on your computer.

What Are You Looking For?

- How to reinstall my operating system

Find it Here

Operating System CD

If you reinstall your operating system, use the ResourceCD to reinstall drivers for the devices that came with your computer (see page 53).

-
- Latest drivers for my computer
 - Answers to technical service and support questions
 - Online discussions with other users and technical support
 - Documentation for my computer

Dell | Support website**support.dell.com**

The Dell | Support website provides several online tools, including:

- Knowledge Base — hints, tips, and online courses
 - Customer Forum — online discussion with other Dell customers
 - Upgrades — upgrade information for components, such as memory, the hard drive, and the operating system
 - Customer Care — contact information, order status, warranty, and repair information
 - Downloads — drivers, patches, and software updates
 - Reference — computer documentation, product specifications, and white papers
-

What Are You Looking For?**Find it Here**

- How to set up my computer

Start Here Setup Diagram

-
- Tips on using Windows
 - How to clean my computer
 - How to use my mouse and keyboard

Tell Me How Help File

- 1** Click the **Start** button, and then click **Help and Support**.
- 2** Click **User and system guides**, and then click **User's guides**.
- 3** Click **Tell Me How**.

-
- How to use Windows® XP
 - Documentation for my computer and devices

Windows XP Help and Support Center

- 1** Click the **Start** button, and then click **Help and Support**.
 - 2** Type a word or phrase that describes your problem, and then click the arrow icon.
 - 3** Click the topic that describes your problem.
 - 4** Follow the instructions shown on the screen.
-

SECTION 1

Setting Up

Attaching and Removing the Computer Stand

Connecting a Printer

Transferring Information to a New Computer

Setting Up a Home and Office Network

Turning Off the Computer

Attaching and Removing the Computer Stand

 **HINT:** Use the green tab inside the front door to rotate the DELL™ logo on the outside of the front door.

Your computer can be used in either a vertical or horizontal position.

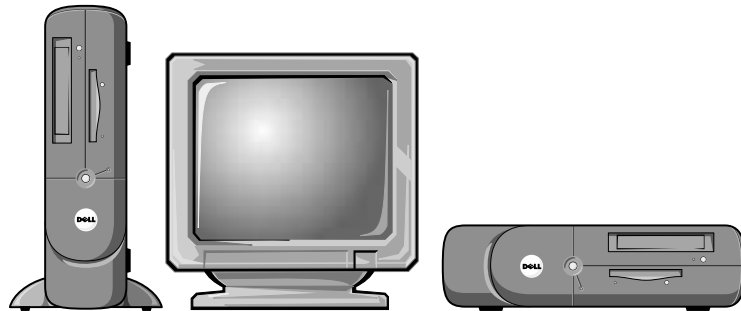

To use the computer in a vertical position, you must attach the computer stand:

- 1 Place the computer on its right side so that the drive bays are at the bottom.
- 2 Fit the stand onto what was the left side of the computer.
 - a Position the stand as shown in the following illustration by aligning the large round hole in the stand with the securing button on the side of the cover and aligning the captive screw in the stand with the screw hole in the cover.
 - b When the stand is in place, tighten the thumbscrew.

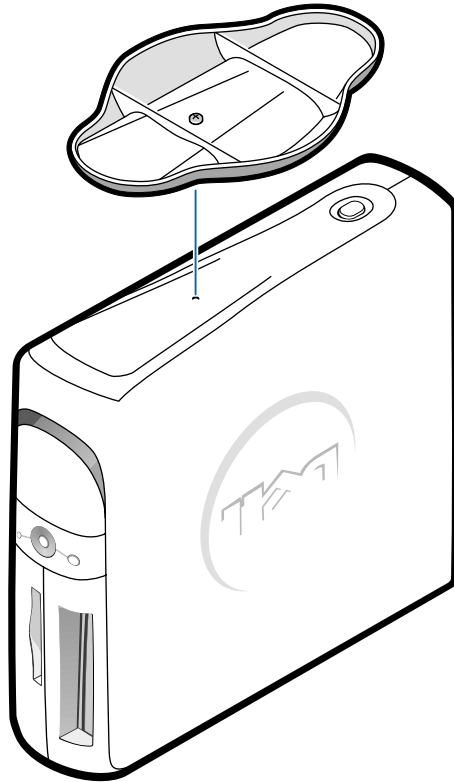

- 3** Rotate the computer so that the stand is at the bottom and the drives are at the top.

To remove the stand:

- 1** Turn the computer over so that the stand is at the top.
- 2** Loosen the thumbscrew and lift the stand away.
- 3** Place the computer in a horizontal position.

Connecting a Printer

See the documentation that came with the printer for any recommended preparation procedures, such as:

- Removing the packaging
- Installing the toner or ink cartridge
- Loading paper

Then follow the instructions that came with the printer to connect it to the computer. If no information is provided, see the following sections.

Parallel Printer

- 1 Turn off the computer (see page 22).

NOTICE: Use only a standard IEEE parallel cable measuring 3 m (10 ft) or less to connect the printer to the computer. Use of a nonstandard cable may prevent the printer from working.

- 2 Attach the parallel printer cable to the parallel connector on the computer and tighten the two screws. Attach the cable to the parallel connector on the printer and snap the two clips into the two notches.

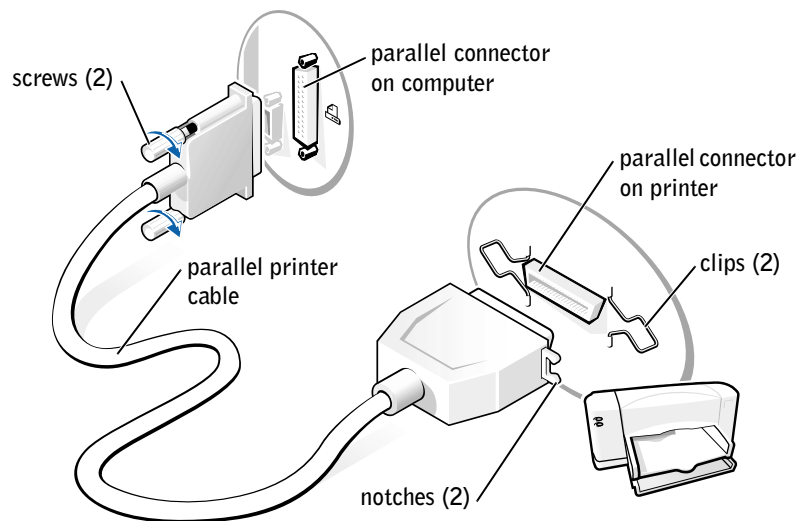



- 3 Turn on the printer and then turn on the computer. If the **Add New Hardware Wizard** window appears, click **Cancel**.
- 4 Install the printer driver if necessary (see "Installing the Printer Driver" on page 19).

USB Printer

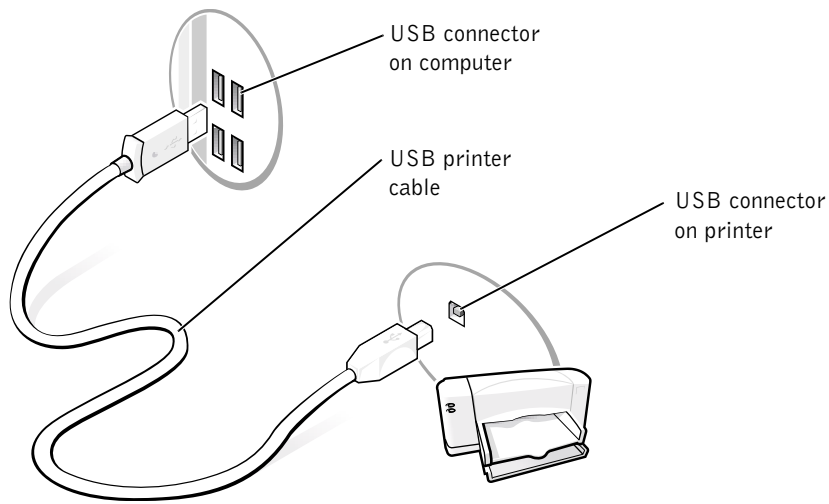
- 1 Install the printer driver if necessary (see the following section).
- 2 Attach the USB printer cable to the USB connector on the computer and the printer. The USB connectors only fit one way.



 **HINT:** You can connect USB devices while the computer is turned on.

 **HINT:** Your computer has four USB connectors on the back panel (see page 61) and two USB connectors inside the door on the front panel (see page 60).

Installing the Printer Driver

If you need to install a printer driver, insert the printer installation CD into the CD or DVD drive. Then follow the prompts on the screen using the instructions that came with the printer.

If your printer installation CD does not automatically run, click the **Start** button on the Microsoft® Windows® desktop, click **Run**, and type `x:\setup.exe` (where *x* is the letter of your CD or DVD drive [usually drive D]). Then click **OK** and follow the prompts on your screen. If your printer installation CD still does not run, check the documentation that came with your printer for instructions on how to start the printer installation CD.

If you connect an older printer and it doesn't work after you install the driver, access the system setup program (see page 78) and ensure that the parallel port is set to operate in bidirectional mode.

To check if your printer driver is installed on a computer, click **Control Panel**, click **Printers and Other Hardware**, and then click **View installed printers or fax printers**. If your printer is listed in the **Printers** window, the printer is ready to use.

Transferring Information to a New Computer

Windows XP provides a Files and Settings Transfer Wizard to move data, such as e-mails, window sizes, toolbar settings, and Internet bookmarks from one computer to another. First you collect the data from the source computer, and then you import the data to the new computer.

If the source computer uses another Windows operating system, the wizard can be launched from the Windows XP operating system CD or from a floppy disk created on the Windows XP computer. You can transfer the data to the new computer over a network or serial connection, or you can store it on a removable medium, such as a floppy disk, a Zip disk, or a writable CD.

To transfer information to a new computer:



HINT: The CD that you need to place in your CD or DVD drive is titled *Operating System*.

- 1 Click the **Start** button, point to **All Programs—> Accessories—> System Tools**, and then click **Files and Settings Transfer Wizard**.
- 2 On the welcome screen, click **Next**.
- 3 On the **Which computer is this?** screen, select **New Computer**, and then click **Next**.
- 4 Follow the instructions on the screen.

Setting Up a Home and Office Network

Connecting to a Network Adapter

Before your computer can communicate on a network, your computer must have a network adapter installed and a network cable connected to it.

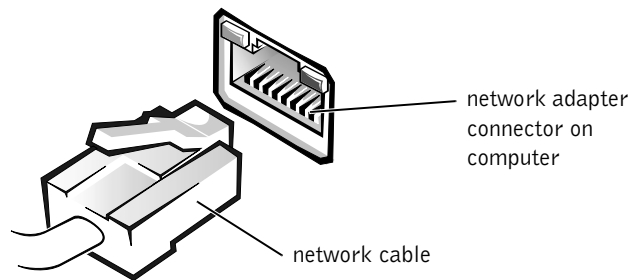

Network Setup Wizard

Windows XP provides a Network Setup Wizard to guide you through the process of sharing files, printers, or an Internet connection between computers in a home or small office.

- 1 Click the **Start** button, point to **All Programs**—>**Accessories**—>**Communications**, and then click **Network Setup Wizard**.
- 2 On the welcome screen, click **Next**.
- 3 Click **checklist for creating a network**.
- 4 Complete the checklist and required preparations, and then return to the Network Setup Wizard.
- 5 Follow the instructions on the screen.

 **HINT:** Selecting the connection method **This computer connects directly to the Internet** enables the integrated firewall provided with Windows XP.



HINT: If you are having difficulty turning off your computer, see "General Problems" on page 33.

Turning Off the Computer

➔ **NOTICE:** To prevent data loss, you must turn off your computer through the **Start** menu rather than by pressing the power button.

- 1 Save and close any open files and exit any open programs.
- 2 Click the **Start** button and then click **Turn off Computer**.
- 3 Click **Turn off**.

The computer automatically turns off after the shutdown process finishes.

- 4 Turn off your monitor and any other devices connected to power.

2

SECTION 2

Solving Problems

- Finding Solutions
- Finding Help Information
- Battery Problems
- Drive Problems
- E-Mail, Modem, and Internet Problems
- Error Messages
- General Problems
- Keyboard Problems
- Mouse Problems
- Network Problems
- Power Problems
- Printer Problems
- Scanner Problems
- Sound and Speaker Problems
- Video and Monitor Problems

Finding Solutions

Sometimes it's difficult to figure out where to go for answers. Use this chart to help you quickly find the answers to your questions.

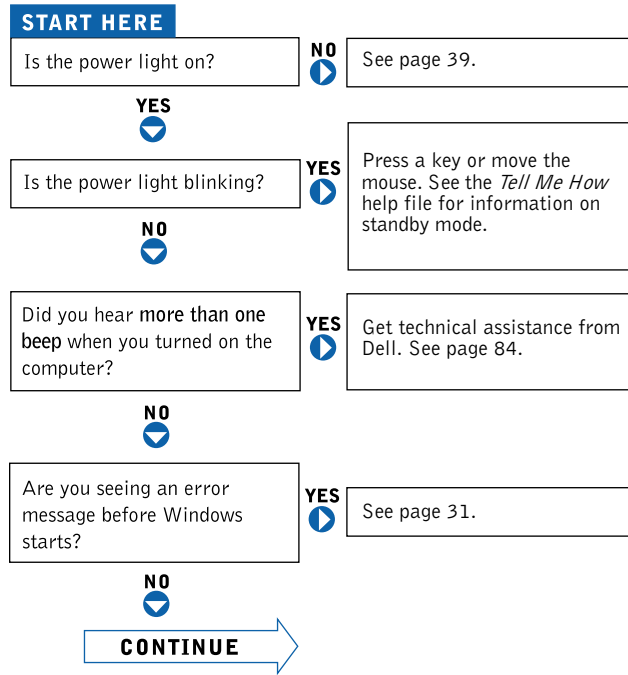

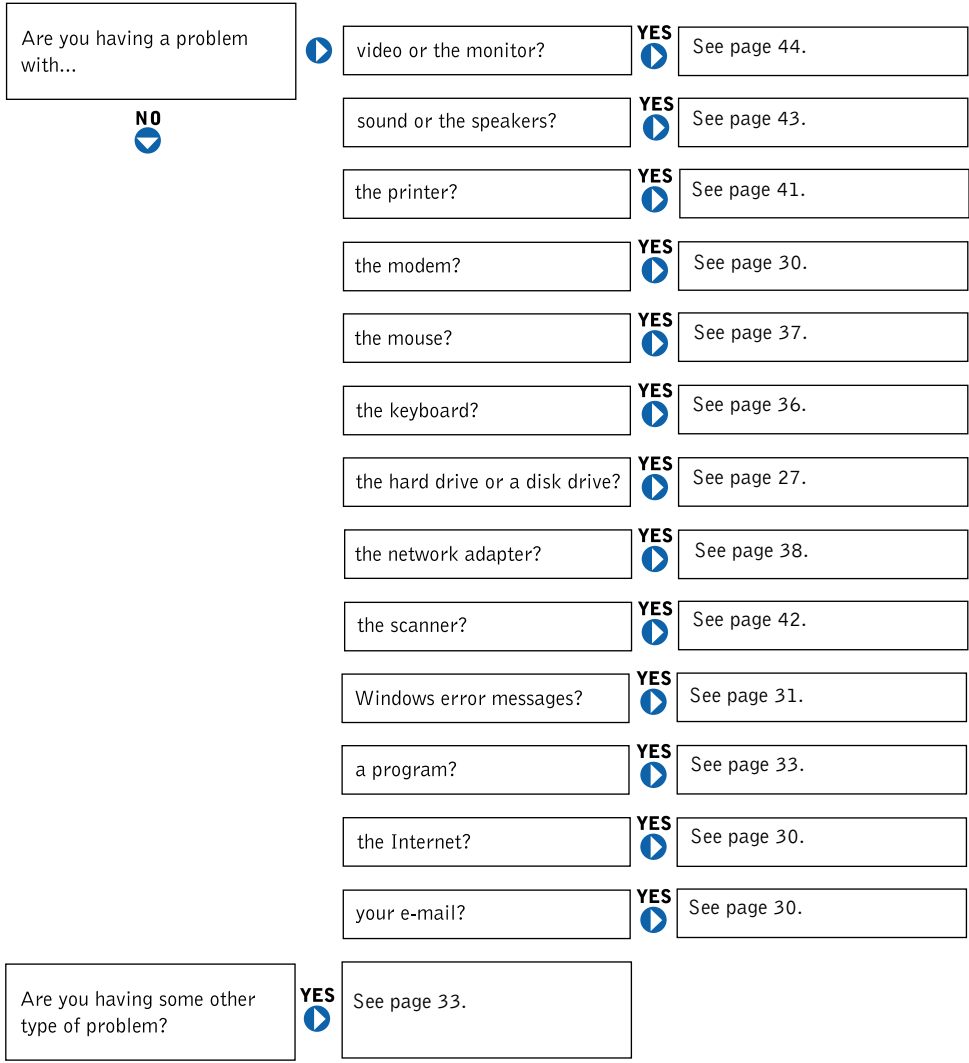

Finding Help Information

TO ACCESS THE *Tell Me How* HELP FILE

- 1 Click the **Start** button, and then click **Help and Support**.
- 2 Click **User and system guides**, and then click **User's guides**.
- 3 Click **Tell Me How**.

TO ACCESS WINDOWS HELP

- 1 Click the **Start** button, and then click **Help and Support**.
- 2 Type a word or phrase that describes your problem, and then click the arrow icon.
- 3 Click the topic that describes your problem.
- 4 Follow the instructions shown on the screen.

TO LOCATE ADDITIONAL INFORMATION FOR YOUR COMPUTER — See page 11.

Battery Problems

 **CAUTION:** There is a danger of a new battery exploding if it is incorrectly installed. Replace the battery only with the same or equivalent type recommended by the manufacturer. Discard used batteries according to the manufacturer's instructions.

 **CAUTION:** Before you begin any of the procedures in this section, follow the safety instructions on page 7.

REPLACE THE BATTERY — If you have to repeatedly reset time and date information after turning on the computer, or if an incorrect time or date displays during start-up, replace the battery (see page 81). If the battery still does not work properly, contact Dell (see page 84).

Drive Problems

Floppy drive problems

ENSURE THAT WINDOWS® RECOGNIZES THE DRIVE — Double-click **My Computer** on the desktop. If the floppy drive is not listed, perform a full scan with your antivirus software to check for and remove viruses. Viruses can sometimes prevent Windows from recognizing the drive.

TEST THE DRIVE

- Insert another disk to eliminate the possibility that the original floppy disk is defective.
- Insert a bootable floppy disk and reboot the computer.

ENSURE THAT THE DISK IS NOT FULL OR WRITE-PROTECTED

Ensure that the disk has available space and that it is not write-protected (locked). See the following illustration.

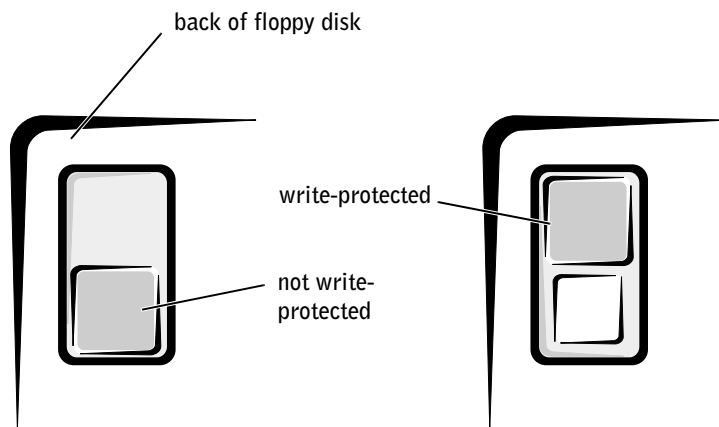

NOTICE: Do not attempt to clean drive heads with a swab. You may accidentally misalign the heads, which can render the drive inoperable.



HINT: High-speed CD drive vibration is normal and may cause noise. This does not indicate a defect in the drive or the CD.

CLEAN THE DRIVE — Use a commercially available cleaning kit.

CD drive problems

ADJUST THE WINDOWS VOLUME CONTROL — Click the speaker icon in the lower-right corner of your screen.

- Ensure that the volume is turned up by clicking the slider and dragging it up.
- Ensure that the sound is not muted by clicking any boxes that are checked.

TEST THE DRIVE WITH ANOTHER CD — Insert another CD to eliminate the possibility that the original CD is defective.

CHECK THE SPEAKERS AND SUBWOOFER — See "Sound and Speaker Problems" on page 43.

ENSURE THAT WINDOWS RECOGNIZES THE DRIVE — Double-click My Computer on the desktop. If the CD drive is not listed, perform a full scan with your antivirus software to check for and remove viruses. Viruses can sometimes prevent Windows from recognizing the drive.

CLEAN THE DISC — See the *Tell Me How* help file for instructions on cleaning your CDs. To access help files, see page 26.

Problems writing to a CD-RW drive

CHANGE THE WRITE SPEED TO A SLOWER RATE — The CD-RW drive must receive a steady stream of data when writing. If the stream is interrupted, an error occurs. Try closing all programs before writing to the CD-RW.

SEE THE CD-RW PROGRAM'S HELP FILE FOR CD-RW RECORDING INSTRUCTIONS — See the CD-RW program's online help information for complete instructions on how to use the program to record CD-RWs.

DVD drive problems

TEST THE DRIVE WITH ANOTHER DVD — Insert another DVD to eliminate the possibility that the original DVD is defective.

ENSURE THAT WINDOWS RECOGNIZES THE DRIVE — Double-click **My Computer** on the desktop. If the DVD drive is not listed, perform a full scan with your antivirus software to check for and remove viruses. Viruses can sometimes prevent Windows from recognizing the drive.

CLEAN THE DISC — See the *Tell Me How* help file for instructions on cleaning your DVDs. To access help files, see page 26.



HINT: Because of different worldwide file types, not all DVD titles work in all DVD drives.

Hard drive problems

RUN CHECK DISK

- 1 Double-click **My Computer** on the desktop.
- 2 Right-click the drive letter (local disk) that you want to scan for errors, and then click **Properties**.
- 3 Click the **Tools** tab.
- 4 Under **Error-checking**, click **Check Now**.
- 5 Click **Start**.



HINT: Connect the modem to an analog telephone jack only. The modem does not operate while it is connected to a digital telephone network.

E-Mail, Modem, and Internet Problems

CHECK THE TELEPHONE LINE CONNECTION — Verify that the telephone line is connected to the jack on the modem. (The jack has either a green label or a connector-shaped icon next to it.) Ensure that you hear a click when you insert the telephone line connector into the modem.

CHECK THE TELEPHONE JACK — Disconnect the telephone line from the modem and connect it to a telephone. Listen for a dial tone.

CONNECT THE MODEM DIRECTLY TO THE TELEPHONE WALL JACK —

If you have other telephone devices sharing the line, such as an answering machine, fax machine, surge protector, or line splitter, then bypass them and use the telephone to connect the modem directly to the telephone wall jack.

USE A DIFFERENT TELEPHONE LINE — If you are using a line that is 3 m (10 ft) or more in length, try a shorter one.

RUN THE MODEM HELPER DIAGNOSTICS — Click the **Start** button, point to **Programs**, and then click **Modem Helper**. Follow the instructions on the screen to identify and resolve modem problems. (Modem Helper is not available on all computers.)

VERIFY THAT THE MODEM IS COMMUNICATING WITH WINDOWS®

- 1 Click the **Start** button, and then click **Control Panel**.
- 2 Click **Printers and Other Hardware**.
- 3 Click **Phone and Modem Options**.
- 4 Click the **Modems** tab.
- 5 Click the COM port for your modem.
- 6 Click **Properties**, click the **Diagnostics** tab, and then click **Query Modem** to verify that the modem is communicating with Windows.
If all commands receive responses, the modem is operating properly.

TURN OFF CALL WAITING (CATCH-PHONE) — See your telephone directory for instructions on deactivating this feature. Then adjust the dial-up networking connection properties.

- 1 Click the **Start** button, and then click **Control Panel**.
- 2 Click **Printers and Other Hardware**, and then click **Phone and Modem Options**.
- 3 Click your connection type to highlight it.
- 4 Click the **Dialing Rules** tab, and then click **Edit**.
- 5 Click the **To Disable Call Waiting** box to place a checkmark in it.
- 6 Select the disable code from the drop-down menu (for example, *70).
- 7 Click **Apply**, and then click **OK**.

ENSURE THAT YOU ARE CONNECTED TO THE INTERNET — With the Outlook Express e-mail program open, click **File**. If **Work Offline** has a checkmark next to it, click the checkmark to remove it and connect to the Internet.

ENSURE THAT YOU HAVE SUBSCRIBED TO AN INTERNET SERVICE PROVIDER — Contact an Internet service provider to subscribe.

CONTACT YOUR INTERNET SERVICE PROVIDER — Contact your Internet service provider for assistance.

CHECK FOR INTERRUPT REQUEST CONFLICTS — See page 54.

Error Messages

A FILENAME CANNOT CONTAIN ANY OF THE FOLLOWING CHARACTERS: \ / : * ? " < > | — Do not use these characters in filenames.

A REQUIRED .DLL FILE WAS NOT FOUND — The program that you are trying to open is missing an essential file. To remove and then reinstall the program:

- 1 Click the **Start** button.
- 2 Click **Control Panel**.
- 3 Click **Add or Remove Programs**.
- 4 Select the program you want to remove.
- 5 Click the **Change or Remove Program** icon.
- 6 See the program documentation for installation instructions.

INSERT BOOTABLE MEDIA — The operating system is trying to boot to a nonbootable floppy disk or CD. Insert a bootable floppy disk or CD.

NON-SYSTEM DISK ERROR — A floppy disk is in the floppy drive. Remove the floppy disk and restart the computer.

NOT ENOUGH MEMORY OR RESOURCES. CLOSE SOME PROGRAMS AND TRY AGAIN — You have too many programs open. Close all windows and open the program that you want to use. In some cases, you might have to restart your computer to restore computer resources. If so, try running the program that you want to use first.

OPERATING SYSTEM NOT FOUND — Contact Dell (see page 84).

THE FILE BEING COPIED IS TOO LARGE FOR THE DESTINATION DRIVE — The file that you are trying to copy is too large to fit on the disk. Try copying the file to a blank disk or using a larger-capacity disk.

x:\ IS NOT ACCESSIBLE. THE DEVICE IS NOT READY — Insert a disk into the drive and try again.

General Problems

The computer stops responding

TURN THE COMPUTER OFF — If your computer locks up and you are unable to get a response by pressing a key on your keyboard or moving your mouse, press and hold the power button for at least 8 to 10 seconds until the computer turns off. Then press the power button again to turn on the computer. You might lose data if you are unable to perform an operating system shutdown.

A program stops responding

END THE PROGRAM

- 1 Press <Ctrl><Shift><Esc> simultaneously.
- 2 Click **Applications**.
- 3 Click the program that is no longer responding.
- 4 Click **End Task**.

A program crashes repeatedly

CHECK THE SOFTWARE DOCUMENTATION — Many software manufacturers maintain websites with information that may help you solve the problem. Ensure that you properly installed and configured the program. If necessary, uninstall and then reinstall the program.

 **HINT:** Software usually includes installation instructions in its documentation or on a floppy disk or CD.

A program is designed for an earlier Windows operating system

RUN THE PROGRAM COMPATIBILITY WIZARD

Windows XP provides a Program Compatibility Wizard that configures a program so it runs in an environment similar to non-Windows XP operating system environments.

- 1 Click the **Start** button, point to **All Programs**—> **Accessories**, and then click **Program Compatibility Wizard**.
- 2 In the welcome screen, click **Next**.
- 3 Follow the instructions on the screen.

A solid blue screen appears

TURN THE COMPUTER OFF — If the computer does not respond to a keystroke or a proper shutdown, press the power button for at least 8 to 10 seconds until the computer turns off. Press the power button again to restart the computer. The chkdsk program automatically runs during the start-up process. Follow the instructions on the screen.

Other software problems

CHECK THE SOFTWARE DOCUMENTATION OR CONTACT THE SOFTWARE MANUFACTURER FOR TROUBLESHOOTING INFORMATION

BACK UP YOUR FILES IMMEDIATELY — If your computer has a CD-RW drive or a zip drive installed, see the drive's documentation for instructions.

ENSURE THAT YOU HAVE NOT MADE AN ERROR WHILE ENTERING DATA — See the program documentation to make sure that the values or characters you are entering are valid.

CHECK FOR VIRUSES — Use a virus-scanning program to check the hard drive, floppy disks, or CDs.

RESTART THE COMPUTER — Save and close any open files, exit any open programs, and then shut down your computer through the **Start** menu instead of pressing the power button. Otherwise, you may lose data.

CHECK FOR COMPATIBILITY

- Ensure that the program is compatible with the operating system installed on your computer and that your computer meets the minimum hardware requirements needed to run the software. See the software documentation for information.
- If necessary, uninstall and then reinstall the program.

ENSURE THAT YOU PROPERLY INSTALLED AND CONFIGURED THE PROGRAM — See the software documentation for information. If necessary, uninstall and then reinstall the program.

Other technical problems

GO TO THE DELL | SUPPORT WEBSITE — Go to support.dell.com for help with general usage, installation, and troubleshooting questions. See "Dell Technical Support Policy" on page 83 for a description of the hardware and software support provided by Dell.

E-MAIL DELL — Go to the Dell | Support website, and then click **E-Mail Dell** in the **Communicate** list. Send an e-mail message to Dell about your problem; you can expect to receive an e-mail message from Dell within hours. See "Dell Technical Support Policy" on page 83 for a description of the hardware and software support provided by Dell.

CALL DELL — If you cannot solve your problem by using the Dell | Support website or e-mail service, call Dell for technical assistance (see page 84). See "Dell Technical Support Policy" on page 83 for a description of the hardware and software support provided by Dell.

General hardware problems

If your computer exhibits one or more of the following symptoms, a device conflict may exist:

- Your computer locks up, particularly while using a specific device.
- A recently added device does not work.
- A sound card emits noise or demonstrates other problems.
- Unintelligible characters print from the printer.
- The mouse pointer does not move or "stutters" when it moves.
- Messages appear stating that the computer is not operating at maximum performance.
- Errors occur and programs crash for no apparent reason.
- Nothing displays on the monitor.

REMOVE ANY RECENTLY ADDED HARDWARE TO SEE IF IT RESOLVES THE CONFLICT — If removing the hardware resolves the conflict, see the hardware documentation for configuration and troubleshooting instructions. If the problem persists, contact the hardware manufacturer for technical assistance.

CHECK YOUR OPERATING SYSTEM DOCUMENTATION FOR ADDITIONAL TROUBLESHOOTING INFORMATION

CHECK FOR INTERRUPT REQUEST CONFLICTS — See page 54.

Keyboard Problems

RESTART THE COMPUTER

- If the mouse is functioning, shut down the computer through the **Start** menu (see page 22). After the computer shuts down, press the power button to restart the computer.
- If the computer does not respond to a keystroke or the mouse, press the power button for at least 8 to 10 seconds until the computer turns off. Press the power button again to restart the computer.

CHECK THE KEYBOARD CABLE

- Shut down the computer (see page 22), reconnect the keyboard cable as shown on the *Start Here* setup diagram for your computer, and then restart the computer.
- Ensure that the keyboard cable is firmly connected to the computer.
- Check the cable connector for bent or broken pins and for damaged or frayed cables. Straighten bent pins.
- Remove keyboard extension cables and connect the keyboard directly to the computer.

TEST THE KEYBOARD — Connect a keyboard that works properly to the computer, and try using the keyboard. If the new keyboard works, the original keyboard is faulty.

CHECK FOR INTERRUPT REQUEST CONFLICTS — See page 54.

Mouse Problems

RESTART THE COMPUTER

- 1 Simultaneously press <Ctrl><Esc> to display the **Start** menu.
- 2 Type **u**, press the keyboard arrow keys to highlight **Shut down** or **Turn Off**, and then press <Enter>.
- 3 After the computer turns off, press the power button to restart the computer.

IF YOU CONNECTED THE MOUSE BEFORE TURNING ON THE COMPUTER, RECONNECT THE MOUSE CABLE

- 1 Simultaneously press <Ctrl><Esc> to display the **Start** menu.
- 2 Type **u**, press the keyboard arrow keys to highlight **Shut down** or **Turn Off**, and then press <Enter>.
- 3 After the computer turns off, reconnect the mouse cable as shown on the *Start Here* setup diagram for your computer.
- 4 Start the computer.

IF YOU CONNECTED THE MOUSE AFTER TURNING ON THE COMPUTER, REMOVE THE POWER CABLE, AND THEN RECONNECT THE MOUSE CABLE

— If the mouse is connected after the power is turned on, the mouse appears to be nonfunctional. To make the mouse function properly:

- 1 While your computer is on, remove the power cable from the back of the computer.
- 2 Connect the mouse to the computer.
- 3 Reconnect the power cable.
- 4 Turn on your computer.

Pressing the power button does not clear the computer's settings and does not restore mouse functionality.

CHECK THE MOUSE CABLE

- Check the cable connector for bent or broken pins and for damaged or frayed cables. Straighten bent pins.
- Ensure that the cable is firmly connected to the computer.

TEST THE MOUSE — Connect a mouse that works properly to the computer, and try using the mouse. If the new mouse works, the original mouse was faulty.

CHECK THE MOUSE SETTINGS

- 1 Click the **Start** button, click **Control Panel**, and then click **Printers and Other Hardware**.
- 2 Click **Mouse**.
- 3 Try adjusting the settings.

REINSTALL THE MOUSE DRIVER — See page 53.

CHECK FOR INTERRUPT REQUEST CONFLICTS — See page 54.

Network Problems

CHECK THE NETWORK CABLE CONNECTOR — Ensure that the network cable is connected as shown on page 21.

CHECK THE NETWORK LIGHTS ON THE BACK OF THE COMPUTER —

No light indicates that there is no network communication. Try replacing the network cable.

These lights indicate there is network communication:

- Green light—indicates a 10-Mbps network connection
- Orange light—indicates a 100-Mbps network connection
- Blinking amber—indicates network traffic

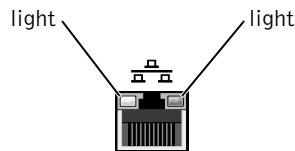

RESTART THE COMPUTER AND TRY TO LOG ON TO THE NETWORK AGAIN

CHECK YOUR NETWORK SETTINGS — Contact your network administrator or the person who set up your network to verify that your network settings are correct and that the network is functioning.

CHECK FOR INTERRUPT REQUEST CONFLICTS — See page 54.

Power Problems

 **CAUTION:** Before you begin any of the procedures in this section, follow the safety instructions on page 7.

ADJUST THE POWER PROPERTIES — Your computer may be in standby or hibernate mode. For information on power conservation modes, see the *Tell Me How* help file, or search for the keyword *standby* or *hibernate* in Windows® Help. To access help files, see page 26.

IF THE POWER LIGHT IS BLINKING GREEN — The computer is in standby mode. Press a key on the keyboard or move the mouse to resume normal operation.

 **HINT:** If the power light on the front of the computer is steady green (see page 60), the computer is operating normally.

IF THE POWER LIGHT IS OFF — The computer is either turned off or is not receiving power.

- Ensure that the power cable is firmly inserted into both the power connector on the back of the computer and the electrical outlet.
- If the computer is plugged into a power strip, ensure that the power strip is plugged into an electrical outlet and that the power strip is turned on.
- Ensure that the electrical outlet is working by testing it with another device, such as a lamp.
- Ensure that the voltage selection switch is set to match the AC power at your location (see page 7).
- Bypass power protection devices, power strips, and power extension cables to verify that the computer turns on.
- Swap the computer and monitor power cables to determine if the power cable is defective.
- Ensure that the microprocessor power cable is securely connected to the system board (see page 65).
- Ensure that the power supply cables are securely connected to the system board (see page 65).
- If the problem persists, contact Dell (see page 84).

IF THE POWER LIGHT IS STEADY AMBER — The computer is receiving electrical power, but an internal power problem might exist.

- Ensure that the power cable is firmly inserted into both the power connector on the back of the computer and the electrical outlet.
- Ensure that the voltage selection switch is set to match the AC power at your location (see page 7).
- Ensure that the microprocessor power cable is securely connected to the system board (see page 65).
- Ensure that the power supply cables are securely connected to the system board (see page 65).
- If the problem persists, contact Dell (see page 84).

IF THE POWER LIGHT IS BLINKING AMBER — A device might be malfunctioning or incorrectly installed.

- Remove and then reinstall the memory modules (see page 70).
- Remove and then reinstall any cards (see page 66).
- If the problem persists, contact Dell (see page 84).

ELIMINATE INTERFERENCE — Electrical appliances on the same circuit or operating near the computer can cause interference. Other causes of interference are:

- Power extension cables
- Keyboard and mouse extension cables
- Too many devices on a power strip
- Multiple power strips connected to the same electrical outlet

Printer Problems

CHECK THE PRINTER DOCUMENTATION — See the printer documentation for setup and troubleshooting information.

ENSURE THAT THE PRINTER IS TURNED ON — See the printer documentation for power button information.

VERIFY THE PRINTER CABLE CONNECTIONS

- See the printer documentation for cable connection information.
- Ensure that the printer cables are securely connected to the printer and the computer (see page 18).

TEST THE ELECTRICAL OUTLET — Ensure that the electrical outlet is working by testing it with another device, such as a lamp.

VERIFY THAT THE PRINTER IS RECOGNIZED BY WINDOWS®

- 1 Click the **Start** button.
- 2 Click **Control Panel**.
- 3 Click **Printers and Other Hardware**.
- 4 Click **View installed printers or fax printers**. If the printer is listed, right-click the printer icon.
- 5 Click **Properties**, and then select the **Ports** tab. For a parallel printer, ensure that the **Print to the following port(s)**: setting is **LPT1 (Printer Port)**. For a USB printer, ensure that the **Print to the following port(s)**: setting is **USB**.

REINSTALL THE PRINTER DRIVER — See the printer documentation for instructions.



HINT: Dell does not cover the printer's warranty. If you need technical assistance for your printer, call the printer's manufacturer. See the printer documentation for the correct phone number.



HINT: Dell does not cover the scanner's warranty. If you need technical assistance for your scanner, call the scanner's manufacturer. See the scanner documentation for the correct phone number.

Scanner Problems

CHECK THE SCANNER DOCUMENTATION — See the scanner documentation for setup and troubleshooting information.

UNLOCK THE SCANNER — Ensure that your scanner is unlocked if it has a locking tab or button.

RESTART THE COMPUTER AND TRY THE SCANNER AGAIN

CHECK THE CABLE CONNECTIONS

- If your scanner has a power cable, ensure that the power cable is firmly connected to a working electrical outlet and that the scanner is turned on.
- Ensure that the scanner cable is firmly connected to the computer and to the scanner.

VERIFY THAT THE SCANNER IS RECOGNIZED BY MICROSOFT® WINDOWS®

- 1 Click the **Start** button.
- 2 Click **Control Panel**.
- 3 Click **Printers and Other Hardware**.
- 4 Click **Scanners and Cameras**. If your scanner is listed, Windows recognizes the scanner.

REINSTALL THE SCANNER DRIVER — See the scanner documentation for instructions.

Sound and Speaker Problems

No sound from speakers

CHECK THE SPEAKER CABLE CONNECTIONS — Ensure that the speakers are connected as shown on the setup diagram supplied with the speakers.

ENSURE THAT THE SUBWOOFER AND THE SPEAKERS ARE TURNED ON — See the setup diagram supplied with the speakers. If your speakers have volume controls, adjust the volume, bass, or treble to eliminate distortion.

ADJUST THE WINDOWS VOLUME CONTROL — Click or double-click the speaker icon in the lower-right corner of your screen. Ensure that the volume is turned up and that the sound is not muted.

DISCONNECT HEADPHONES FROM THE HEADPHONE CONNECTOR — Sound from the speakers is automatically disabled when headphones are connected to the computer's front-panel headphone connector.

TEST THE ELECTRICAL OUTLET — Ensure that the electrical outlet is working by testing it with another device, such as a lamp.

ELIMINATE POSSIBLE INTERFERENCE — Turn off nearby fans, fluorescent lights, or halogen lamps to check for interference.

RUN THE SPEAKER DIAGNOSTICS — Some speaker systems have self-diagnostics. See the speaker documentation for diagnostics instructions.

REINSTALL THE AUDIO (SOUND) DRIVER — See page 53.

CHECK FOR INTERRUPT REQUEST CONFLICTS — See page 54.



HINT: The volume control in some MP3 players overrides the Windows® volume setting. If you have been listening to MP3 songs, ensure that you did not turn the player volume down or off.

No sound from headphones

CHECK THE HEADPHONE CABLE CONNECTION — Ensure that the headphone cable is securely inserted into the headphone connector (see page 60).

DISABLE DIGITAL MODE — Your headphones do not work if the CD drive is operating in digital mode. To disable digital mode:

- 1 Click **Control Panel**, and then double-click **Sounds and Audio Devices**.
- 2 Click the **Hardware** tab.
- 3 Double-click the name of your CD drive.
- 4 Click the **Properties** tab.
- 5 Uncheck the **Enable digital CD audio for this CD-ROM device** box.

ADJUST THE WINDOWS VOLUME CONTROL — Click or double-click the speaker icon in the lower-right corner of your screen. Ensure that the volume is turned up and that the sound is not muted.

Video and Monitor Problems

If the screen is blank



HINT: See the monitor documentation for troubleshooting procedures.

CHECK THE MONITOR POWER LIGHT — If the power light is off, firmly press the button to ensure that the monitor is turned on. If the power light is lit or blinking, the monitor has power. If the power light is blinking, press a key on the keyboard or move the mouse.

CHECK THE MONITOR CABLE CONNECTION — Check the connector for bent or broken pins. (It is normal for monitor cable connectors to have missing pins.) Ensure that the video cable is connected as shown on the *Start Here* setup diagram for your computer.

TEST THE ELECTRICAL OUTLET — Ensure that the electrical outlet is working by testing it with another device, such as a lamp.

SWAP THE POWER CABLES — Swap the computer and monitor power cables to determine if the power cable is defective.

TEST THE VIDEO EXTENSION CABLE (IF USED) — If you are using a video extension cable and removing the cable solves the problem, the cable is defective.

TEST ANOTHER MONITOR — If another monitor is available, connect it to the computer.

CHECK THE DIAGNOSTIC LIGHTS — See page 48.

If the screen is difficult to read

CHECK THE MONITOR SETTINGS — See the monitor documentation for instructions on adjusting the contrast and brightness, demagnetizing (degaussing) the monitor, and running the monitor self-test.

MOVE THE SUBWOOFER AWAY FROM THE MONITOR — If your speaker system includes a subwoofer, ensure that the subwoofer is at least 60 cm (2 ft) away from the monitor.

MOVE THE MONITOR AWAY FROM EXTERNAL POWER SOURCES — Fans, fluorescent lights, halogen lamps, and other electrical devices can cause the screen image to appear "shaky." Turn off nearby devices to check for interference.

ROTATE THE MONITOR TO FACE A DIFFERENT DIRECTION — Eliminate sunlight glare, which can cause poor picture quality.

ADJUST THE WINDOWS® DISPLAY SETTINGS

- 1 Click the **Start** button, and then click **Control Panel**.
- 2 Click **Appearance and Themes**.
- 3 Click **Display**, and then click the **Settings** tab.
- 4 Try different settings for **Screen resolution** and **Color quality**.

RESTORE THE RECOMMENDED SETTINGS — Restore the original resolution and refresh rate settings. See the *Tell Me How* help file for instructions. To access help files, see page 26.

3

SECTION 3

Advanced Troubleshooting

Diagnostic Lights

Using System Restore

Reinstalling Drivers

Resolving Software and Hardware Incompatibilities



Reinstalling Windows® XP

Diagnostic Lights

To help you troubleshoot a problem, your computer is equipped with four lights on the back panel labeled "A," "B," "C," and "D" (see page 61). These lights can be yellow or green. When the computer starts normally, the lights flash. After the computer starts, the lights remain green. If the computer malfunctions, the color and sequence of the lights identify the problem.

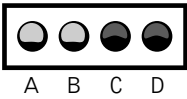
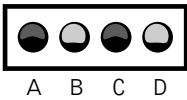
⚠ CAUTION: Before you begin any of the procedures in this section, follow the safety instructions on page 7.

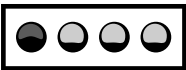
Diagnostic Code	Definition	Corrective Action
<p>Y Y G G</p>  <p>A B C D</p>	<p>Memory modules are detected, but a memory failure has occurred.</p>	<ul style="list-style-type: none"> • If you have one memory module installed, reinstall it (see page 70), and then restart the computer. • If you have two or more memory modules installed, remove the modules, reinstall one module (see page 70), and then restart the computer. If the computer starts normally, reinstall an additional module. Continue until you identify a faulty module or reinstall all modules without error. • If available, install properly working memory of the same type into your computer (see page 70). • If the problem persists, contact Dell (see page 84).
<p>G Y G Y</p>  <p>A B C D</p>	<p>Memory modules are detected, but a memory configuration or compatibility error exists.</p>	<ul style="list-style-type: none"> • Be sure that there are no special memory module/memory connector placement requirements (see page 70). • Verify that the memory modules that you are installing are compatible with the computer (see page 74). • If the problem persists, contact Dell (see page 84).

Diagnostic Code	Definition	Corrective Action
<p>G Y Y Y</p>  <p>A B C D</p>	<p>No memory modules are detected.</p>	<ul style="list-style-type: none"> • Reinstall all memory modules (see page 70) and then restart the computer. • To eliminate the possibility of a faulty memory connector, remove all memory modules, install one memory module (if the system supports a single module), and restart the system. Then move the memory module to another connector and restart the system. • If the problem persists, contact Dell (see page 84).
<p>Y G Y Y</p>  <p>A B C D</p>	<p>PCI bus failure has occurred.</p>	<ol style="list-style-type: none"> 1 Determine if a conflict exists by removing a card (see page 66) and then restarting the computer. 2 If the problem persists, reinstall the card that you removed, remove a different card (see page 66), and then restart the computer. 3 Repeat this process for each card. If the computer starts normally, troubleshoot the last card removed from the computer for resource conflicts (see "Resolving Software and Hardware Incompatibilities" on page 54). 4 If the problem persists, contact Dell (see page 84).
<p>Y G Y G</p>  <p>A B C D</p>	<p>Video controller failure.</p>	<ul style="list-style-type: none"> • If the problem persists, contact Dell (see page 84).

Diagnostic Code	Definition	Corrective Action
G G G Y  A B C D	Other failure.	<ul style="list-style-type: none"> • Ensure that the cables are properly connected from the hard drive, CD drive, and DVD drive to the system board (see page 65). • If the problem persists, contact Dell (see page 84).

Using System Restore

The Microsoft® Windows® XP operating system provides System Restore to allow you to return your computer to an earlier operating state (without affecting data files) if changes to the hardware, software, or other system settings have left the computer in an undesirable operating state. System Restore also includes the following features.

 **NOTICE:** Make regular backups of your data files. System Restore does not monitor your data files or recover them.

Creating a Restore Point

Using the System Restore Wizard

- 1 Click the **Start** button.
- 2 Click **Help and Support**.
- 3 Click **System Restore**.
- 4 Follow the instructions on the screen.

Manually Creating Restore Points

- 1 Click the **Start** button, point to **All Programs—> Accessories—> System Tools**, and then click **System Restore**.
- 2 Click **Create a restore point**.
- 3 Click **Next**.
- 4 Type a name for your new restore point in the **Restore point description** field.

The present date and time are automatically added to your restore point.

- 5 Click **Create**.
- 6 Click **OK**.

Restoring the Computer to an Earlier Operating State

If problems occur after installing a device driver, first try using Device Driver Rollback (see page 53). If that is unsuccessful, then use System Restore.

 **NOTICE:** Before restoring the computer to an earlier operating state, save and close all open files and close all open programs. Do not alter, open, or delete any files or programs until the system restoration is complete.

- 1 Click the **Start** button, point to **All Programs—> Accessories—> System Tools**, and then click **System Restore**.
- 2 Ensure that **Restore my computer to an earlier time** is selected, and then click **Next**.
- 3 Click a calendar date to which you want to restore your computer.

The **Select a Restore Point** screen provides a calendar that allows you to see and select restore points. All calendar dates with available restore points appear in bold.

- 4 Select a restore point, and then click **Next**.

If a calendar date has only one restore point, then that restore point is automatically selected. If two or more restore points are available, click the restore point that you prefer.

- 5 Click **Next**.

The **Restoration Complete** screen appears after System Restore finishes collecting data, and then the computer automatically restarts.

- 6 After the computer restarts, click **OK**.

To change the restore point, you can either repeat the steps using a different restore point, or you can undo the restoration.

Undoing the Last System Restore



NOTICE: Before undoing the last system restore, save and close all open files and close all open programs. Do not alter, open, or delete any files or programs until the system restoration is complete.

- 1 Click the **Start** button, point to **All Programs—> Accessories—> System Tools**, and then click **System Restore**.
- 2 Select **Undo my last restoration** and click **Next**.
- 3 Click **Next**.

The **System Restore** screen appears, and then the computer automatically restarts.

- 4 After the computer restarts, click **OK**.

Enabling System Restore

If you reinstall Windows XP with less than 200 MB of free hard-disk space available, System Restore is automatically disabled. To see if System Restore is enabled:

- 1 Click the **Start** button, and then click **Control Panel**.
- 2 Click **Performance and Maintenance**.
- 3 Click **System**.
- 4 Click the **System Restore** tab.
- 5 Make sure that **Turn off System Restore** is unchecked.

Reinstalling Drivers

 **NOTICE:** The Dell | Support website and the *Dell Dimension ResourceCD* provide approved drivers for Dell™ computers. If you install drivers obtained from other sources, your computer might not work correctly.

A driver is a software program that allows a hardware device controller to function properly and to communicate with the computer. Sometimes you can fix a device problem by reinstalling its driver.

Using Windows® XP Device Driver Rollback

Windows XP Device Driver Rollback replaces a device driver with the previously installed version if you install a new driver that causes system instability. If Device Driver Rollback does not resolve the problem, then try using System Restore (see page 50) to return your operating system to the operating state it was in before you installed the new device driver.

To use Device Driver Rollback:

- 1 Click the **Start** button, and then right-click **My Computer**.
- 2 Click **Properties**.
- 3 Click the **Hardware** tab, and then click **Device Manager**.
- 4 In the **Device Manager** window, right-click the device for which the new driver was installed, and then click **Properties**.
- 5 Click the **Drivers** tab.
- 6 Click **Roll Back Driver**.

Using the Dell Dimension ResourceCD

If using Device Driver Rollback or System Restore does not resolve the problem, then reinstall the driver from the *Dell Dimension ResourceCD*:

- 1 With the Windows desktop displayed, insert the ResourceCD into the CD or DVD drive.
If this is your first time to use the ResourceCD, go to step 2. If not, go to step 5.
- 2 When the ResourceCD Installation program starts, follow the prompts on the screen.



HINT: The ResourceCD displays drivers only for hardware that came on your computer. If you installed additional hardware, those drivers might not be displayed by the ResourceCD. If those drivers are not displayed, exit the ResourceCD program. For drivers information, see the documentation that came with that product.

- 3 When the **InstallShield Wizard Complete** window appears, remove the ResourceCD and click **Finish** to restart the computer.
- 4 When you see the Windows desktop, reinsert the ResourceCD into the CD or DVD drive.
- 5 At the **Welcome Dell System Owner** screen, click **Next**.

A message stating that the ResourceCD is detecting hardware in your computer appears.

The drivers that are used by your computer are automatically displayed in the **My Drivers—The ResourceCD has identified these components in your system** window.

- 6 Click the driver that you want to reinstall and follow the instructions on the screen.

If a particular driver is not listed, then that driver is not required by your operating system.

Resolving Software and Hardware Incompatibilities

Microsoft® Windows® XP IRQ conflicts occur if a device either is not detected during the operating system setup or is detected but incorrectly configured.

To check for conflicts on a computer running Windows XP:

- 1 Click the **Start** button, and then click **Control Panel**.
- 2 Click **Performance and Maintenance**, and then click **System**.
- 3 Click the **Hardware** tab, and then click **Device Manager**.
- 4 In the **Device Manager** list, check for conflicts with the other devices.

Conflicts are indicated by a yellow exclamation point (!) beside the conflicting device or a red x if the device has been disabled.

- 5 Double-click any conflicting device listed to bring up the **Properties** window to determine what needs to be reconfigured or removed from the Device Manager.

Resolve these conflicts before checking specific devices.

- 6 Double-click the malfunctioning device type in the **Device Manager** list.
- 7 Double-click the icon for the specific device in the expanded list.
The **Properties** window appears.
- 8 Resolve any **IRQ** conflicts, as described in step 5.
If an **IRQ** conflict exists, the **Device** status area in the **Properties** window reports the cards or devices that share the device's **IRQ**.

You can also use the Windows XP Hardware Troubleshooter:

- 1 Click the **Start** button.
- 2 Click **Help and Support**.
- 3 Type `hardware troubleshooter` in the **Search** field, and then click the arrow to start the search.
- 4 Click **Hardware Troubleshooter** in the **Search Results** list.
- 5 In the **Hardware Troubleshooter** list, click **I need to resolve a hardware conflict on my computer**.
- 6 Click **Next**.

Reinstalling Windows® XP

Before reinstalling the Microsoft® Windows XP operating system to correct a problem, try correcting the problem by performing a Windows XP System Restore (see page 50). The reinstallation process can take 1 to 2 hours, and you will need to reinstall your drivers, virus protection program, and other software when the process is complete.

- ➔ **NOTICE:** The *Operating System* CD provides options for reinstalling your Windows XP operating system. The options can potentially overwrite files installed by Dell and possibly affect programs installed on your hard drive. Therefore, Dell does not recommend that you reinstall your operating system unless instructed to do so by a Dell technical support representative.
- ➔ **NOTICE:** To prevent conflicts with Windows XP, you must disable any virus protection software installed on your computer before you reinstall Windows XP.

To reinstall Windows XP:

- 1 To reinstall Windows XP, insert the *Operating System* CD into the CD or DVD drive.

Close any program or utility that might run after you insert the CD into the drive.

- 2 Turn off the computer (see page 22), and then turn the computer on again.

- 3 When the blue DELL™ logo appears, press <F12> immediately.

If you wait too long and the operating system logo appears, continue to wait until you see the Microsoft Windows desktop. Then shut down the computer and try again.

- 4 Use the arrow keys to select the CD-ROM option, and then press <Enter>.

- 5 When the **Windows XP Setup** screen appears, press <Enter> to select **To set up Windows now**.

- 6 Read the information in the **License Agreement** window, and then press <F8> on your keyboard to agree with the license information.

- 7 If your computer already has Windows XP installed and you want to recover your current Windows XP data, type *r* to select the repair option, and then go to step 16.

If you want to install a new copy of Windows XP, press <Esc> to select the fresh copy option, and then press <Enter> on the next screen to select the highlighted partition (recommended). Then follow the instructions on the screen.

The **Windows XP Setup** screen appears and Windows XP begins to copy files and install the devices. The computer automatically restarts multiple times before it requires additional input.

- 8 When the **Welcome to Microsoft** screen appears, click the green arrow icon at the bottom of the screen to continue. Follow the directions on the screen to finish.

- 9 When the **Regional Settings** screen appears, select the settings for your locale, and then click **Next**.

- 10 Enter your name and organization in the **Personalize Your Software** screen, and then click **Next**.

- 11** If you are reinstalling Windows XP Home Edition, enter a name for your computer when the **Computer Name** window appears, and then click **Next**.

If you are reinstalling Windows XP Professional, enter a name for your computer and a password when the **Computer Name and Administrator Password** window appears, and then click **Next**.

- 12** If the **Modem Dialing Information** screen appears, enter the requested information. Then click **Next**.
- 13** Enter the date, time, and time zone in the **Date and Time Settings** window, and then click **Next**.
- 14** If you have a network card in your computer, select the appropriate network settings.

If you do not have a network card, this option does not appear.

Windows XP begins to install its components and configure the computer. The computer automatically restarts.

- 15** When the **Welcome to Microsoft** screen appears, click the green arrow icon at the bottom of the screen to continue. Follow the directions on the screen to finish.
- 16** Remove the CD from the drive.
- 17** Reinstall the appropriate drivers (see page 53).
- 18** Reinstall your virus protection software.
- 19** Reinstall your other software programs.

See the documentation supplied with the software for instructions.

4

SECTION 4

Adding Parts

Front and Back View of the Computer

Opening the Computer Cover

Looking Inside Your Computer

Adding Cards

Adding Memory

Closing the Computer Cover

Front and Back View of the Computer

Front View

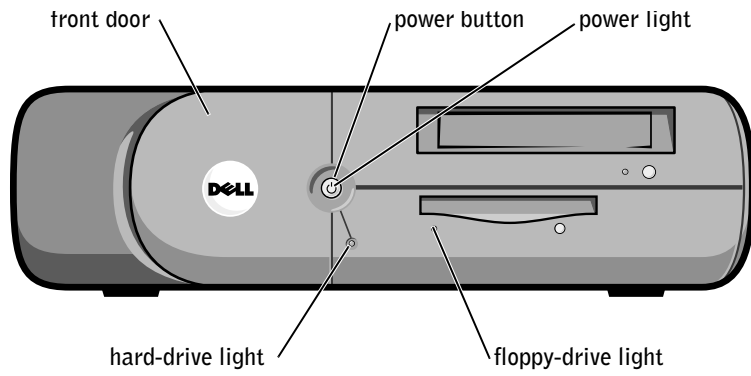

 **HINT:** The front-panel door is removable; if you remove it or accidentally knock it off its hinges, it snaps back in place.

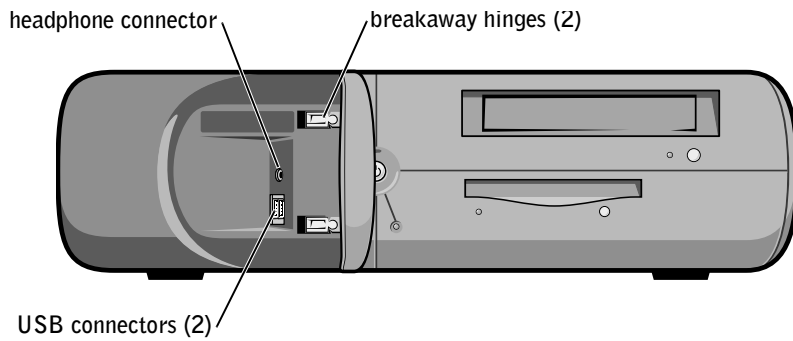

Back View

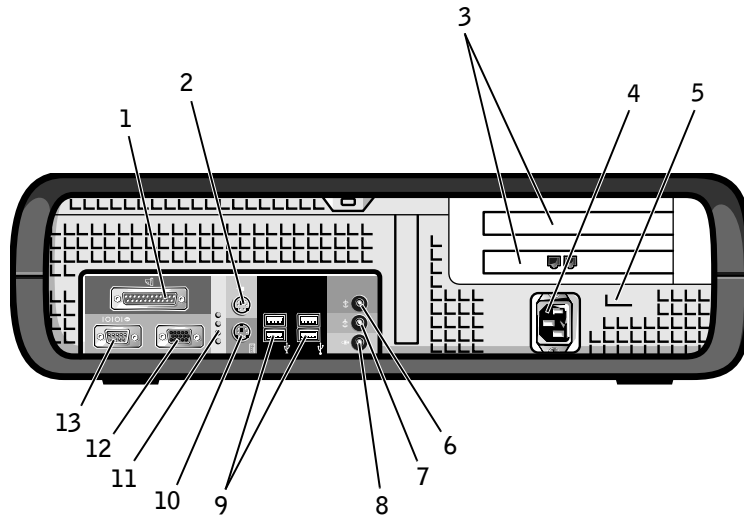

1	parallel connector	Connect a parallel device, such as a printer, to the parallel connector. If you have a USB printer, plug it into a USB connector.
2	mouse connector	Plug a standard mouse into the green mouse connector. Turn off the computer and any attached devices before you connect a mouse to the computer. If you have a USB mouse, plug it into a USB connector.
3	card slots	The slots for PCI cards.
4	power connector	The connection for the power cable.
5	voltage selection switch (may not be available on all computers)	Your computer is equipped with either a fixed-voltage power supply, an auto-sensing voltage circuit, or a manual voltage selection switch. See "Safety Instructions" on page 7 for more information.
6	line-in connector	Use the blue line-in connector (available on computers with integrated sound) to attach a record/playback device such as a cassette player, CD player, or VCR. On computers with a sound card, the line-in connector is on the card.

7	line-out connector	Use the green line-out connector (available on computers with integrated sound) to attach headphones and most speakers with integrated amplifiers. On computers with a sound card, the line-out connector is on the card.
8	microphone connector	Use the pink microphone connector (available on computers with integrated sound) to attach a personal computer microphone for voice or musical input into a sound or telephony program. On computers with a sound card, the microphone connector is on the card.
9	USB connectors	Connect USB devices such as a mouse, keyboard, printer, joystick, and computer speakers into any of the USB connectors.
10	keyboard connector	If you have a standard keyboard, plug it into the purple keyboard connector. If you have a USB keyboard, plug it into a USB connector.
11	diagnostic lights	Use the lights to help you troubleshoot a computer problem based on the diagnostic code. For more information, see page 48.
12	video connector	Plug the cable from your monitor into the blue connector.
13	serial connector	Connect a serial device, such as a handheld device, to the serial port.

Opening the Computer Cover

 **CAUTION:** Before you begin any of the procedures in this section, follow the safety instructions on page 7.

 **CAUTION:** To guard against electrical shock, always unplug your computer from the electrical outlet before opening the cover.

1 Shut down the computer (see page 22).

2 Turn off any attached devices and disconnect them from their electrical outlets.

 **NOTICE:** To disconnect a network cable, first unplug the cable from your computer and then unplug it from the network wall jack.

3 Disconnect the computer power cable from the wall outlet, and then press the power button to ground the system board.

4 Remove the computer stand, if it is attached (see page 16).

 **NOTICE:** Ensure that there is sufficient space to support the open cover—at least 30 cm (1 ft) of desk top space.

5 Press the two release buttons until the cover is free to swing up.

➡ **NOTICE:** Open the cover slowly to ensure that you do not damage any cables.

6 Raise the back of the cover, and pivot it toward the front of the computer.

⚠ **CAUTION:** If the system board standby power light is on (see page 65), the computer is still plugged into an electrical outlet. Unplug the computer from the electrical outlet before proceeding.

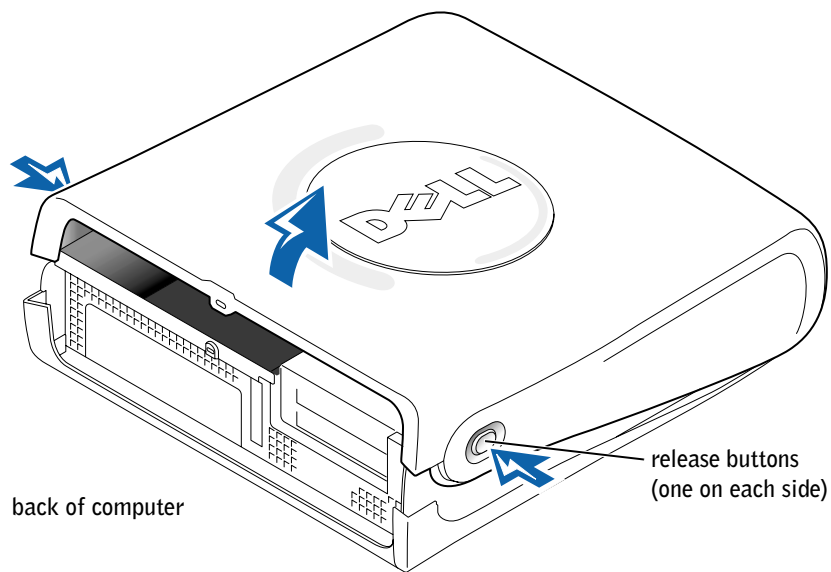

Looking Inside Your Computer

⚠ CAUTION: Before you begin any of the procedures in this section, follow the safety instructions on page 7.

⚠ CAUTION: To guard against electrical shock, always unplug your computer from the electrical outlet before opening the cover.

➡ NOTICE: Be careful when opening the computer cover to ensure that you do not inadvertently disconnect cables from the system board.

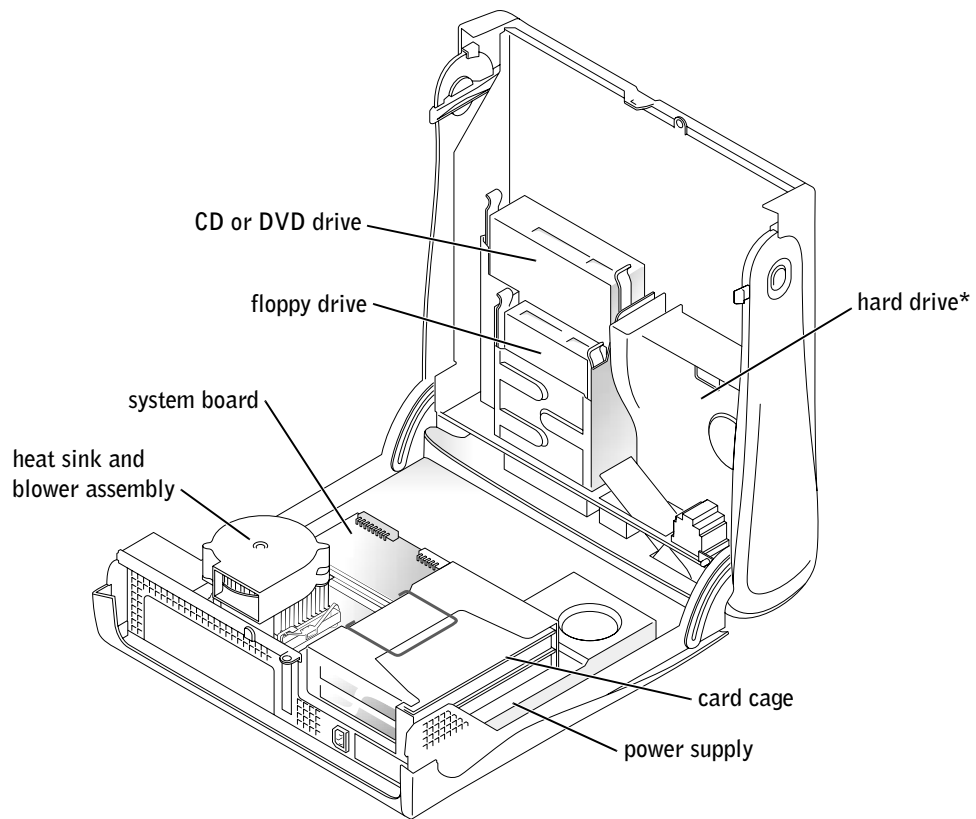

* Your computer's hard drive may or may not have a plastic shroud cover. Operating the computer without a hard-drive shroud does not affect its performance.

System Board

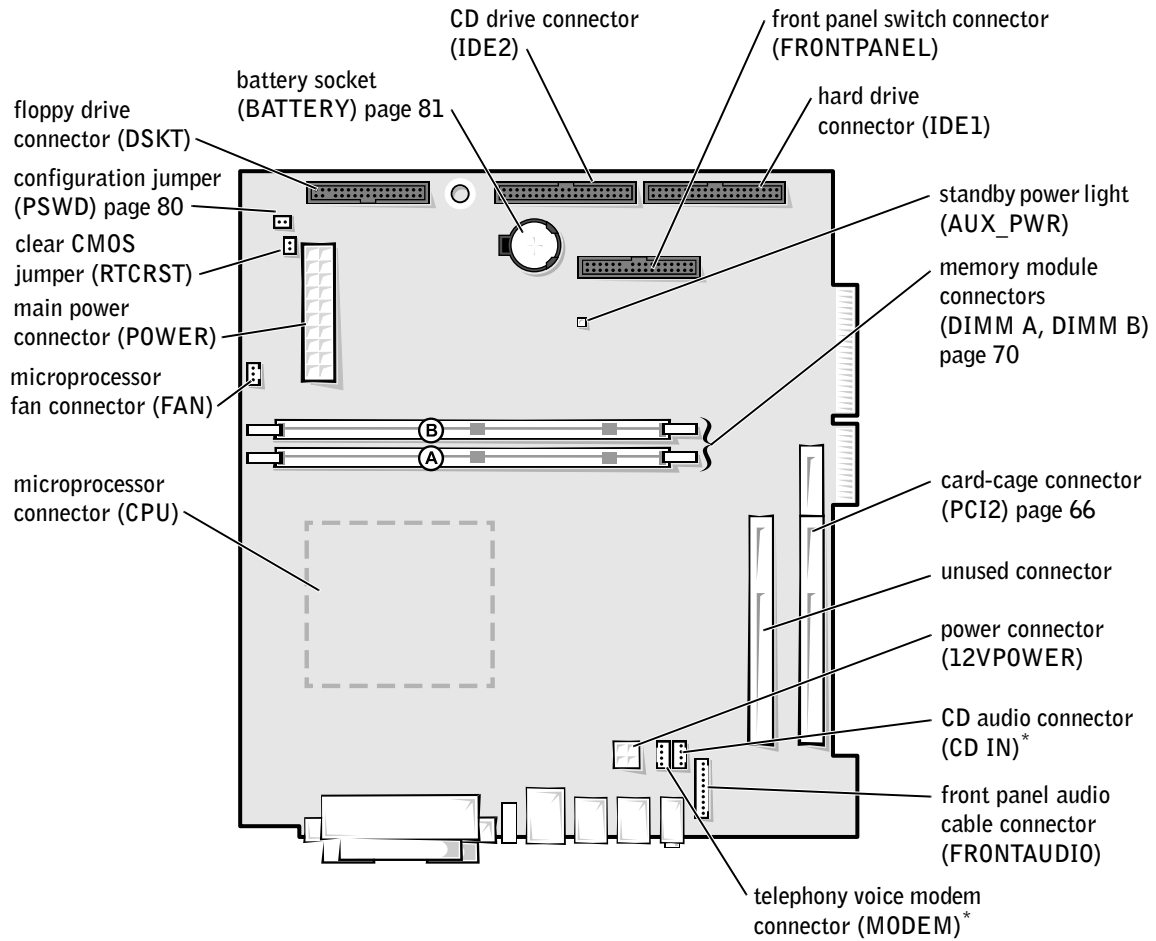

back of computer

* On computers with integrated audio.

Adding Cards

 **CAUTION:** Before you begin any of the procedures in this section, follow the safety instructions on page 7.

 **CAUTION:** To guard against electrical shock, always unplug your computer from the electrical outlet before opening the cover.

The computer's card connectors allow you to install different types of devices such as modems and network adapters.

- 1 Shut down the computer (see page 22).
- 2 Turn off any attached devices and disconnect them from their electrical outlets.
-  **NOTICE:** To disconnect a network cable, first unplug the cable from your computer and then unplug it from the network wall jack.
- 3 Disconnect the computer power cable from the wall outlet, and then press the power button to ground the system board.
- 4 Remove the computer stand, if it is attached (see page 16).
- 5 Open the computer cover (see page 62).
- 6 Remove the card cage:
 - a Check any cables connected to cards through the back-panel openings. Disconnect any cables that will not reach the card cage once it is removed from the computer.

- b** Gently pull on the handle and lift the card cage up and away from the computer.

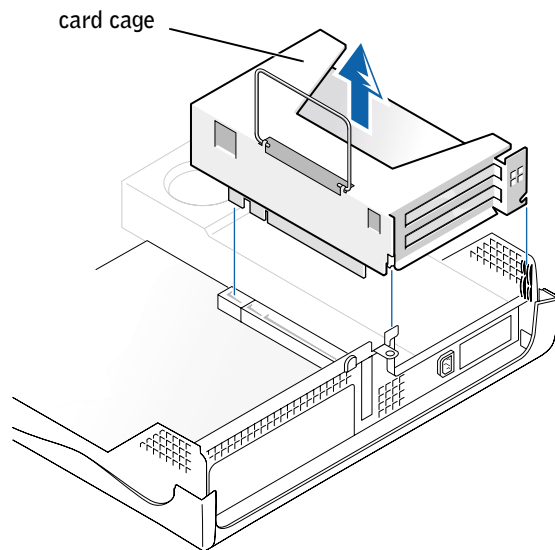

- 7 Press the lever on the retention arm and raise the retention arm.

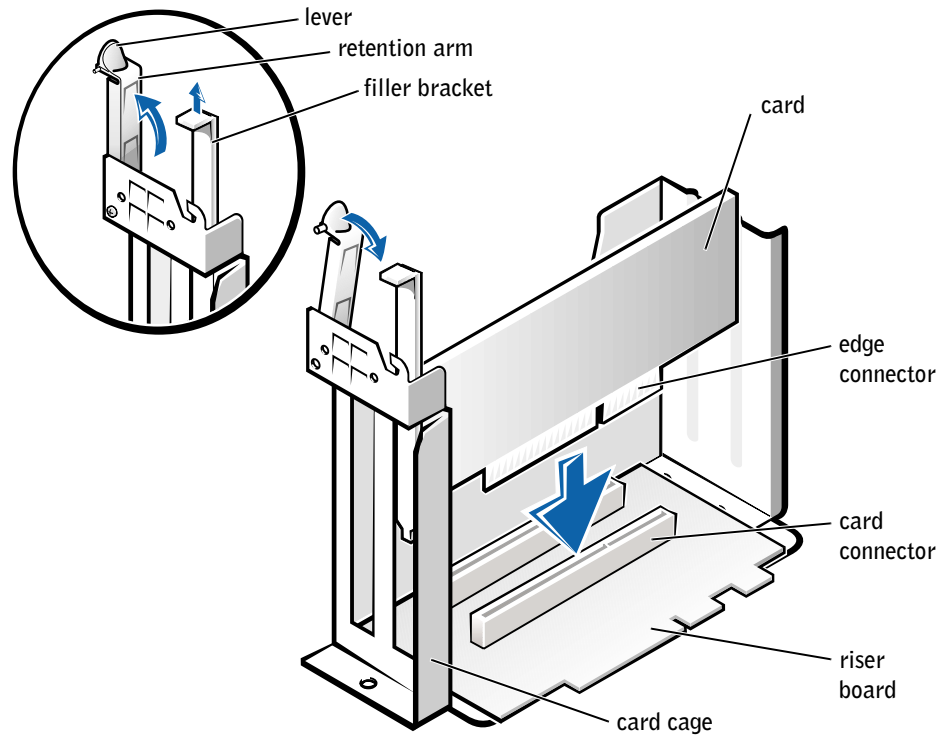

- 8 If you are installing a new card, remove the filler bracket to create an empty card-slot opening.
If you are replacing a card that is already installed in the computer, remove the card. If necessary, disconnect any cables connected to the card. Grasp the card by its top corners, and ease it out of its connector.
- 9 Prepare the card for installation.
See the documentation that came with the card for information on configuring the card, making internal connections, or otherwise customizing it for your computer.

⚠ CAUTION: Some network adapters automatically start the computer when they are connected to a network. To guard against electrical shock, be sure to unplug your computer from its electrical outlet before installing any cards.

10 Insert the card into the card connector.



If the card is full-length, insert the end of the card into the card guide bracket as you lower the card toward its connector on the system board. Insert the card firmly into the card connector on the riser board.

11 Lower the retention arm and press it into place, securing the card(s) in the computer.

12 Replace the card cage:

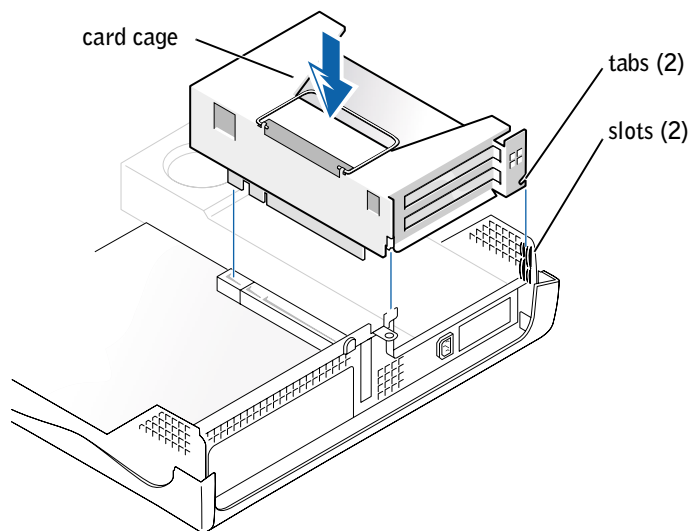
- a Align the tabs in the side of the card cage with the slots on the side of the computer, and slide the card cage down into place.
- b Make sure that the riser board is fully seated in the connector on the system board.



- 13 Reconnect any cables that you removed in step 6.
- 14 Connect any cables that should be attached to the card.
See the documentation for the card for information about the card's cable connections.
-  **NOTICE:** Do not route card cables over or behind the cards. Cables routed over the cards can prevent the computer cover from closing properly or cause damage to the equipment.
- 15 Close the computer cover (see page 72).
- 16 Attach the computer stand (optional) (see page 16).
- 17 Connect your computer and devices to electrical outlets, and turn them on.
-  **NOTICE:** To connect a network cable, first plug the cable into the network wall jack and then plug it into the computer.
- 18 Install any drivers required for the card as described in the card documentation.

Adding Memory

 **CAUTION:** Before you begin any of the procedures in this section, follow the safety instructions on page 7.

 **CAUTION:** To guard against electrical shock, always unplug your computer from the electrical outlet before opening the cover.

You can increase your computer memory by installing memory modules on the system board. For information on the type of memory supported by your computer, look under "Memory" in "Technical Specifications" on page 74.

 **HINT:** Memory purchased from Dell is covered under your computer warranty.

- 1 Shut down the computer (see page 22).
-  **NOTICE:** To disconnect a network cable, first unplug the cable from your computer and then unplug it from the network wall jack.
- 2 Turn off any attached devices and disconnect them from their electrical outlets.
- 3 Disconnect the computer power cable from the wall outlet, and then press the power button to ground the system board.
- 4 Remove the computer stand, if it is attached (see page 16).
- 5 Open the computer cover (see page 62).

Removing a Memory Module

- 1 Press out the securing clip at each end of the memory module connector.
- 2 Grasp the module and pull up.

If the module is difficult to remove, gently ease the module back and forth to remove it from the connector.

Adding a Memory Module

- 1 Press out the securing clip at each end of the memory module connector.

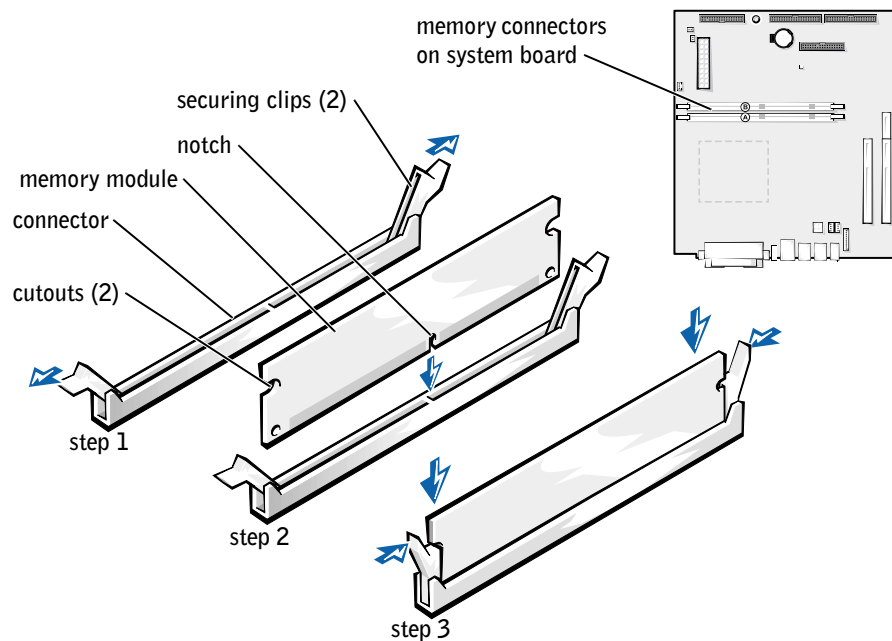

- 2 Align the notch on the bottom of the module with the crossbar in the connector.

NOTICE: To avoid damage to the memory module, press the module straight down into the socket with equal force applied at each end of the module.

- 3 Insert the module straight down into the connector, ensuring that it fits into the vertical guides at each end of the connector. Press firmly on the ends of the module until it snaps into place.

If you insert the module correctly, the securing clips snap into the cutouts at each end of the module.

- 4 Close the computer cover (see page 72).

- 5 Attach the computer stand (optional) (see page 16).

➔ **NOTICE:** To connect a network cable, first plug the cable into the network wall jack and then plug it into the computer.

- 6 Connect your computer and devices to electrical outlets, and turn them on.

- 7 Right-click the **My Computer** icon and then click **Properties**.

- 8 Click the **General** tab.

- 9 To verify that the memory is installed correctly, check the amount of memory (RAM) listed.

Closing the Computer Cover

- 1 Ensure that all cables are connected, and fold cables out of the way. Make sure cables are not routed over the drive cage—they will prevent the cover from closing properly.

- 2 Ensure that no tools or extra parts are left inside the computer.

- 3 Pivot the cover down and ensure that the release buttons click into place.

- 4 Attach the computer stand (optional) (see page 16).

➔ **NOTICE:** To connect a network cable, first plug the cable into the network wall jack and then plug it into the computer.

- 5 Connect your computer and devices to electrical outlets, and turn them on.

5

SECTION 5

Appendix

- Specifications
- Standard Settings
- Clearing Forgotten Passwords
- Replacing the Battery
- Dell Technical Support Policy (U.S. Only)
- Contacting Dell
- Regulatory Information
- Limited Warranties and Return Policy

Specifications

Microprocessor

Microprocessor type	Intel® Pentium® 4 or Celeron®
L1 cache	8 KB first-level (Pentium 4); 32 KB (Celeron)
L2 cache	256- or 512-KB (displayed in the system setup program) pipelined-burst, eight-way set associative, write-back SRAM (Pentium 4); 128-KB SRAM (Celeron)

System Information

System chip set	Intel 845 G
DMA channels	seven
Interrupt levels	24 APIC mode
System BIOS chip	4 Mb (512 KB)
System clock	400- or 533-MHz data rate

Expansion Bus

Bus types	PCI
Bus speed	PCI: 33 MHz
PCI connectors	two
PCI connector size	120 pins
PCI connector data width (maximum)	32 bits

Memory

Architecture	DDR SDRAM
Memory connectors	two
Memory capacities	128-, 256-, 384-, 512-, or 768-MB, or 1-GB non-ECC DDR SDRAM
Minimum memory	128 MB
Maximum memory	2 GB
Memory type	266-MHz DDR SDRAM (non-ECC)
BIOS address	F0000h

Drives

Externally accessible	one 5.25-inch bay one 3.5-inch bay
Internally accessible	one bay for 1-inch-high IDE hard drive
Available devices	ATA-66 or ATA-100 Ultra DMA hard drive, CD drive, Zip drive, DVD drive, and CD-RW drive

Ports and Connectors

Externally accessible:

Serial	9-pin connector; 16550C-compatible
Parallel	25-hole connector (bidirectional)
Video	15-hole connector
Keyboard	6-pin mini-DIN connector or USB connector
Mouse	6-pin mini-DIN connector or USB connector
USB	two front-panel and four back-panel USB 2.0-compliant connectors
Headphone	front-panel miniature jack
Audio	three miniature jacks for line-in, line-out, and microphone

Internally accessible:

Primary IDE channel	40-pin connector on PCI local bus
Secondary IDE channel	40-pin connector on PCI local bus
Floppy drive	34-pin connector

Video

Video controller	Intel integrated AGP graphics
------------------	-------------------------------

Audio

Audio controller	ADI 1981A (AC97 Codec)
------------------	------------------------

Controls and Lights

Power control	push button
Power light	green light on power button—blinking green in sleep state; solid green for power on state
Hard-drive access light	green
Diagnostic code lights	four bicolor (yellow and green) located on back panel
System board standby power light	yellow—indicates system board is receiving standby power

Power

DC power supply:

Wattage	180 W
Heat dissipation	500 BTU (fully-loaded computer without monitor)
Voltage (see page 7 for important voltage setting information)	fixed-voltage power supply—110 V at 50/60 Hz manual selection and auto-sensing power supplies—90 to 135 V at 50/60 Hz; 180 to 265 V at 50/60 Hz; 100 V at 50/60 Hz for Japanese computers

Backup battery	3-V CR2032 coin cell
----------------	----------------------

Physical

Height x Width x Depth	10.6 x 38.9 x 43.2 cm (4.2 x 15.3 x 17 inches)
Weight	9.9 kg (22 lb)

Environmental

Temperature:

Operating	10° to 35°C (50° to 95°F) ¹
Storage	-40° to 65°C (-40° to 149°F)

Relative humidity	20% to 80% (noncondensing)
-------------------	----------------------------

¹ At 35°C (95°F), the maximum operating altitude is 914 m (3000 ft).

Environmental *(continued)*

Maximum vibration:

Operating	0.25 G at 3 to 200 Hz at 1/2 octave/min
Storage	0.5 G at 3 to 200 Hz at 1/2 octave/min

Maximum shock:

Operating	bottom half-sine pulse with a change in velocity of 50.8 cm/sec (20 inches/sec)
Storage	23-G faired-square wave with a velocity change of 508 cm/sec (200 inches/sec)

Altitude:

Operating	-15.2 to 3048 m (-50 to 10,000 ft) ²
Storage	-15.2 to 10,670 m (-50 to 35,000 ft)

²At 35°C (95°F), the maximum operating altitude is 914 m (3000 ft).

Standard Settings

The system setup program contains the standard settings for your computer.

NOTICE: Unless you are an expert computer user, don't change the settings for this program. Certain changes might make your computer work incorrectly.

See the following figure for an example of the main program screen.

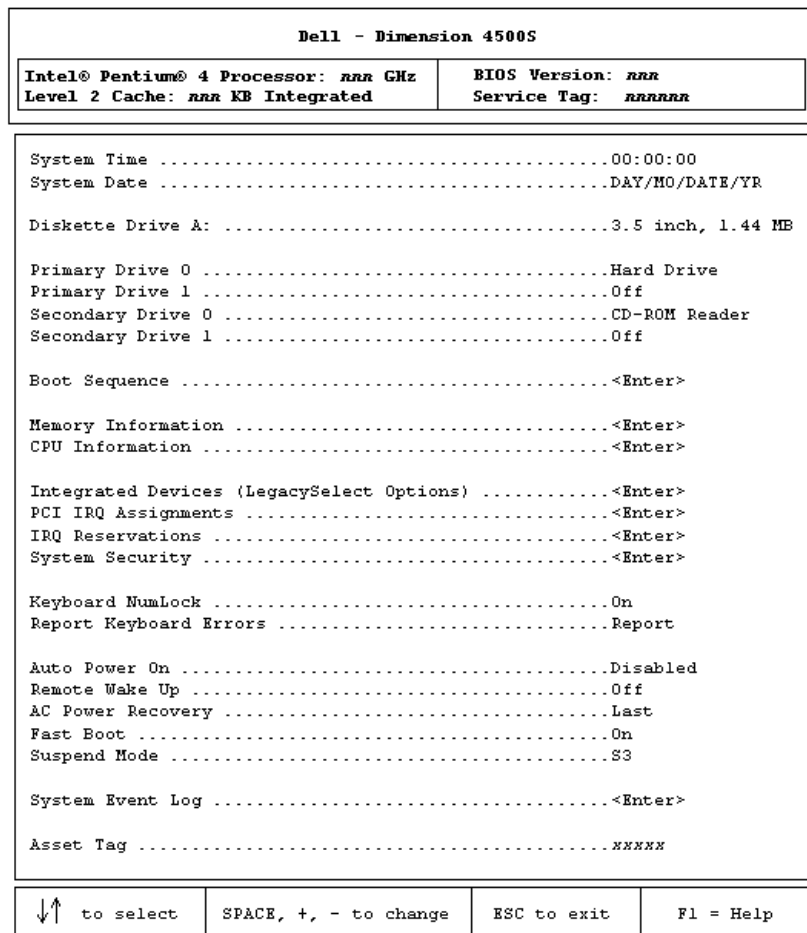

Viewing Settings

- 1 Turn on (or restart) your computer.
- 2 When the blue DELL™ logo appears, press <F2> immediately.

If you wait too long and the operating system logo appears, continue to wait until you see the Microsoft® Windows® desktop. Then shut down your computer and try again.

System Setup Program Screens

The system setup program screens display the current configuration information for your computer. Information on the screen is divided into five areas:

- Title – The area at the top of all system setup screens that displays your computer's model number.
- Computer data – Two boxes below the title that display the system processor, L2 cache, service tag, and the version number of the BIOS.
- Options – A scrollable box listing options that define the configuration of your computer (including installed hardware, power conservation, and security features).

Fields to the right of the listed options contain settings or values. The settings and values that you can change are brighter on the screen. All other settings and values are set by the computer and cannot be changed. When <Enter> appears to the right of an option, press <Enter> to access a pop-up menu of additional options.

- Key functions – A line of boxes across the bottom of all system setup screens that lists keys and their functions within the system setup program.
- Help – Press <F1> for information on the option that is selected (highlighted).

Clearing Forgotten Passwords

 **CAUTION:** Before you begin any of the procedures in this section, follow the safety instructions on page 7.

If you forget your user or setup password, you cannot operate your computer or change settings in the system setup program until you clear the forgotten password(s).

 **NOTICE:** This process erases both the system and setup passwords.

- 1 Shut down the computer (see page 22).
- 2 Turn off any attached devices and disconnect them from their electrical outlets.

 **NOTICE:** To disconnect a network cable, first unplug the cable from your computer and then unplug it from the network wall jack.

- 3 Disconnect the computer power cable from the wall outlet, and then press the power button to ground the system board.
- 4 Remove the computer stand, if it is attached (see page 17).
- 5 Open the computer cover (see page 62).
- 6 Locate jumper PSWD on the system board (see page 65) and remove the jumper plug.
- 7 Close the computer cover (see page 72), plug your computer into an electrical outlet, and turn on the computer.

The existing password(s) will be erased.

- 8 Shut down the computer (see page 22).
- 9 Turn off any attached devices and disconnect them from their electrical outlets.

 **NOTICE:** To disconnect a network cable, first unplug the cable from your computer and then unplug it from the network wall jack.

- 10 Disconnect the computer power cable from the wall outlet, and then press the power button to ground the system board.
- 11 Open the computer cover (see page 62).
- 12 Reconnect the jumper plug to jumper PSWD (see page 65).
- 13 Close the computer cover (see page 72).

- 14 Attach the computer stand (optional) (see page 16).
 - 15 Connect your computer and devices to their electrical outlets, and turn them on.
-  **NOTICE:** To connect a network cable, first plug the cable into the network wall jack and then plug it into the computer.

Turning on your computer with the PSWD jumper installed reenables the password feature.

Replacing the Battery

 **CAUTION:** Before you begin any of the procedures in this section, follow the safety instructions on page 7.

A coin-cell battery maintains computer configuration, date, and time information. The battery can last several years.

If you have to repeatedly reset time and date information after turning on the computer, replace the battery.

 **CAUTION:** A new battery can explode if it is incorrectly installed. Replace the 3-V CR2032 battery only with the same or equivalent type recommended by the manufacturer. Discard used batteries according to the manufacturer's instructions.

- 1 Record all the screens in the system setup program (see page 78) so that you can restore the correct settings in step 9.
- 2 Remove the computer stand, if it is attached (see page 17).
- 3 Open the computer cover (see page 62).
- 4 Locate the battery socket BATTERY (see page 65).
- 5 Remove the battery by carefully prying it out of its socket with your fingers or with a blunt, nonconducting object such as a plastic screwdriver.

- ➔ **NOTICE:** To avoid damage to the system board while you pry the battery loose, be sure to insert the plastic screwdriver between the battery and the socket (not the system board).

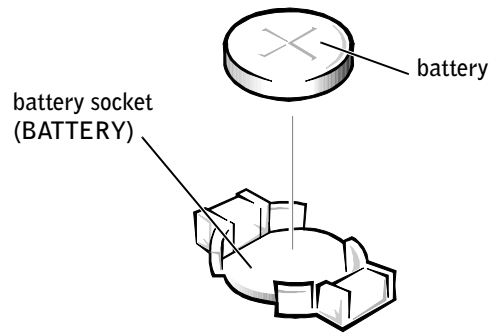

- 6 Insert the new battery into the socket with the side labeled "+" facing up and snap it into place.
 - 7 Attach the computer stand (optional) (see page 16).
 - 8 Connect your computer and devices to electrical outlets, and turn them on.
- ➔ **NOTICE:** To connect a network cable, first plug the cable into the network wall jack and then plug it into the computer.
- 9 Access the system setup program (see page 78) and restore the settings you recorded in step 1.
 - 10 Properly dispose of the old battery (see page 10).

Dell Technical Support Policy (U.S. Only)

Technician-assisted technical support requires the cooperation and participation of the customer in the troubleshooting process and provides for restoration of the operating system, application software, and hardware drivers to the original default configuration as shipped from Dell, as well as the verification of appropriate functionality of the computer and all Dell-installed hardware. In addition to this technician-assisted technical support, online technical support is available at support.dell.com. Additional technical support options may be available for purchase.

Dell provides limited technical support for the computer and any "Dell-installed" software and peripherals¹. Support for third-party software and peripherals is provided by the original manufacturer, including those purchased and/or installed through Dell Software and Peripherals, Readyware, and Custom Factory Integration (DellPlus™)².

- ¹ Repair services are provided pursuant to the terms and conditions of your limited warranty and any optional support service contract purchased with the computer.
- ² All Dell-standard components included in a Custom Factory Integration (CFI) project are covered by the standard Dell limited warranty for your computer. However, Dell also extends a parts replacement program to cover all nonstandard, third-party hardware components integrated through CFI for the duration of the computer's service contract.

Definition of "Dell-Installed" Software and Peripherals

Dell-installed software includes the operating system and some of the application software that is preinstalled on the computer during the manufacturing process (Microsoft Office, Norton Antivirus, and so on).

Dell-installed peripherals include any internal expansion cards, or Dell-branded module bay or PC Card accessories. In addition, any Dell-branded monitors, keyboards, mice, speakers, microphones for telephonic modems, docking stations/port replicators, networking products, and all associated cabling are included.

Definition of "Third-Party" Software and Peripherals

Third-party software and peripherals include any peripheral, accessory, or application software sold by Dell not under the Dell brand (printers, scanners, cameras, games, and so on). Support for all third-party software and peripherals is provided by the original manufacturer of the product.

Contacting Dell

 **HINT:** Toll-free numbers are for use within the country for which they are listed.

When you need to contact Dell, use the telephone numbers, codes, and electronic addresses provided in the following tables. If you need assistance in determining which codes to use, contact a local or an international operator.

See "Dell Technical Support Policy" on page 83 for a description of the hardware and software support provided by Dell.

Contact Numbers and Addresses

Country (City) International Access Code Country Code City Code	Department Name or Service Area, Website and E-Mail Address	Area Codes, Local Numbers, and Toll-Free Numbers
Antigua and Barbuda	General Support	1-800-805-5924
Argentina (Buenos Aires)	Tech Support and Customer Care	toll-free: 0-800-444-0733
International Access Code: 00	Sales	1-810-444-3355
Country Code: 54	Tech Support Fax	11 4515 7139
City Code: 11	Customer Care Fax	11 4515 7138
	Website: www.dell.com.ar	
Australia (Sydney)	Home and Small Business	1-300-65-55-33
International Access Code: 0011	Government and Business	toll-free: 1-800-633-559
Country Code: 61	Preferred Accounts Division (PAD)	toll-free: 1-800-060-889
City Code: 2	Customer Care	toll-free: 1-800-819-339
	Corporate Sales	toll-free: 1-800-808-385
	Transaction Sales	toll-free: 1-800-808-312
	Fax	toll-free: 1-800-818-341

Country (City) International Access Code Country Code City Code	Department Name or Service Area, Website and E-Mail Address	Area Codes, Local Numbers, and Toll-Free Numbers
Austria (Vienna)	Home/Small Business Sales	01 795 67602
International Access Code: 900	Home/Small Business Fax	01 795 67605
Country Code: 43	Home/Small Business Customer Care	01 795 67603
City Code: 1	Preferred Accounts/Corporate Customer Care	0660 8056
	Home/Small Business Technical Support	01 795 67604
	Preferred Accounts/Corporate Technical Support	0660 8779
	Switchboard	01 491 04 0
	Website: support.euro.dell.com	
	E-mail: tech_support_central_europe@dell.com	
Barbados	General Support	1-800-534-3066
Belgium (Brussels)	Technical Support	02 481 92 88
International Access Code: 00	Customer Care	02 481 91 19
Country Code: 32	Home/Small Business Sales	toll-free: 0800 16884
City Code: 2	Corporate Sales	02 481 91 00
	Fax	02 481 92 99
	Switchboard	02 481 91 00
	Website: support.euro.dell.com	
	E-mail: tech_be@dell.com	
	E-mail for French Speaking Customers: support.euro.dell.com/be/fr/emaildell/	
Bermuda	General Support	1-800-342-0671
Brazil	Customer Support, Technical Support	0800 90 3355
International Access Code: 00	Tech Support Fax	51 481 5470
Country Code: 55	Customer Care Fax	51 481 5480
City Code: 51	Sales	0800 90 3390
	Website: www.dell.com/br	
Brunei	Customer Technical Support (Penang, Malaysia)	604 633 4966
Country Code: 673	Customer Service (Penang, Malaysia)	604 633 4949
	Transaction Sales (Penang, Malaysia)	604 633 4955

Country (City) International Access Code Country Code City Code	Department Name or Service Area, Website and E-Mail Address	Area Codes, Local Numbers, and Toll-Free Numbers
Canada (North York, Ontario) International Access Code: 011	Automated Order-Status System	toll-free: 1-800-433-9014
	AutoTech (Automated technical support)	toll-free: 1-800-247-9362
	Customer Care (From outside Toronto)	toll-free: 1-800-387-5759
	Customer Care (From within Toronto)	416 758-2400
	Customer Technical Support	toll-free: 1-800-847-4096
	Sales (Direct sales—from outside Toronto)	toll-free: 1-800-387-5752
	Sales (Direct sales—from within Toronto)	416 758-2200
	Sales (Federal government, education, and medical)	toll-free: 1-800-567-7542
	Sales (Major accounts)	toll-free: 1-800-387-5755
	TechFax	toll-free: 1-800-950-1329
Cayman Islands	General Support	1-800-805-7541
Chile (Santiago) Country Code: 56 City Code: 2	Sales, Customer Support, and Technical Support	toll-free: 1230-020-4823
China (Xiamen) Country Code: 86 City Code: 592	Home and Small Business Technical Support	toll-free: 800 858 2437
	Corporate Accounts Technical Support	toll-free: 800 858 2333
	Customer Experience	toll-free: 800 858 2060
	Home and Small Business	toll-free: 800 858 2222
	Preferred Accounts Division	toll-free: 800 858 2062
	Large Corporate Accounts North	toll-free: 800 858 2999
	Large Corporate Accounts East	toll-free: 800 858 2020
	Large Corporate Accounts South	toll-free: 800 858 2355
	Large Corporate Accounts GCP	toll-free: 800 858 2055
	Large Corporate Accounts HK	toll-free: 800 964108
	Large Corporate Accounts GCP HK	toll-free: 800 907308
Colombia	General Support	980-9-15-3978
Costa Rica	General Support	0800-012-0435

Country (City) International Access Code Country Code City Code	Department Name or Service Area, Website and E-Mail Address	Area Codes, Local Numbers, and Toll-Free Numbers
Czech Republic (Prague)	Technical Support	02 22 83 27 27
International Access Code: 00	Customer Care	02 22 83 27 11
Country Code: 420	Fax	02 22 83 27 14
City Code: 2	TechFax	02 22 83 27 28
	Switchboard	02 22 83 27 11
	Website: support.euro.dell.com	
	E-mail: czech_dell@dell.com	
Denmark (Copenhagen)	Technical Support	7023 0182
International Access Code: 00	Customer Care(Relational)	7023 0184
Country Code: 45	Home/Small Business Customer Care	3287 5505
	Switchboard (Relational)	3287 1200
	Fax Switchboard (Relational)	3287 1201
	Switchboard (Home/Small Business)	3287 5000
	Fax Switchboard (Home/Small Business)	3287 5001
	Website: support.euro.dell.com	
	E-mail Support (Portable Computers): den_nbk_support@dell.com	
	E-mail Support (Desktop Computers): den_support@dell.com	
	E-mail Support (Servers): Nordic_server_support@dell.com	
Dominican Republic	General Support	1-800-148-0530
El Salvador	General Support	01-899-753-0777

Country (City) International Access Code Country Code City Code	Department Name or Service Area, Website and E-Mail Address	Area Codes, Local Numbers, and Toll-Free Numbers
Finland (Helsinki)	Technical Support	09 253 313 60
International Access Code: 990	Technical Support Fax	09 253 313 81
Country Code: 358	Relational Customer Care	09 253 313 38
City Code: 9	Home/Small Business Customer Care	09 693 791 94
	Fax	09 253 313 99
	Switchboard	09 253 313 00
	Website: support.euro.dell.com	
	E-mail: fin_support@dell.com	
	E-mail Support (Servers): Nordic_support@dell.com	
France (Paris) (Montpellier)	Home and Small Business	
International Access Code: 00	Technical Support	0825 387 270
Country Code: 33	Customer Care	0825 823 833
City Codes: (1) (4)	Switchboard	0825 004 700
	Switchboard (Calls from outside of France)	04 99 75 40 00
	Sales	0825 004 700
	Fax	0825 004 701
	Fax (Calls from outside of France)	04 99 75 40 01
	Website: support.euro.dell.com	
	E-mail: support.euro.dell.com/fr/fr/emaildell/	
	Corporate	
	Technical Support	0825 004 719
	Customer Care	0825 338 339
	Switchboard	01 55 94 71 00
	Sales	01 55 94 71 00
	Fax	01 55 94 71 01
	Website: support.euro.dell.com	
	E-mail: support.euro.dell.com/fr/fr/emaildell/	

Country (City) International Access Code Country Code City Code	Department Name or Service Area, Website and E-Mail Address	Area Codes, Local Numbers, and Toll-Free Numbers
Germany (Langen)	Technical Support	06103 766-7200
International Access Code: 00	Home/Small Business Customer Care	0180-5-224400
Country Code: 49	Global Segment Customer Care	06103 766-9570
City Code: 6103	Preferred Accounts Customer Care	06103 766-9420
	Large Accounts Customer Care	06103 766-9560
	Public Accounts Customer Care	06103 766-9555
	Switchboard	06103 766-7000
	Website: support.euro.dell.com	
	E-mail: tech_support_central_europe@dell.com	
Guatemala	General Support	1-800-999-0136
Hong Kong	Technical Support	toll-free: 800 96 4107
International Access Code: 001	Customer Service (Penang, Malaysia)	604 633 4949
Country Code: 852	Transaction Sales	toll-free: 800 96 4109
	Corporate Sales	toll-free: 800 96 4108
India	Technical Support	1600 33 8045
	Sales	1600 33 8044
Ireland (Cherrywood)	Ireland Technical Support	1850 543 543
International Access Code: 16	UK Technical Support (dial number within UK only)	0870 908 0800
Country Code: 353	Home User Customer Care	01 204 4095
City Code: 1	Small Business Customer Care	01 204 4444
	UK Customer Care (dial number within UK only)	0870 906 0010
	Corporate Customer Care	01 204 4003
	Ireland Sales	01 204 4444
	UK Sales (dial number within UK only)	0870 907 4000
	SalesFax	01 204 0144
	Fax	01 204 5960
	Switchboard	01 204 4444
	Website: support.euro.dell.com	
	E-mail: dell_direct_support@dell.com	

Country (City) International Access Code Country Code City Code	Department Name or Service Area, Website and E-Mail Address	Area Codes, Local Numbers, and Toll-Free Numbers
Italy (Milan) International Access Code: 00 Country Code: 39 City Code: 02	Home and Small Business	
	Technical Support	02 577 826 90
	Customer Care	02 696 821 14
	Fax	02 696 821 13
	Switchboard	02 696 821 12
	Website: support.euro.dell.com	
	E-mail: support.euro.dell.com/it/it/zdell/	
	Corporate	
	Technical Support	02 577 826 90
	Customer Care	02 577 825 55
Fax	02 575 035 30	
Switchboard	02 577 821	
Website: support.euro.dell.com		
E-mail: support.euro.dell.com/it/it/emaildell/		
Jamaica	General Support	1-800-682-3639

Country (City) International Access Code Country Code City Code	Department Name or Service Area, Website and E-Mail Address	Area Codes, Local Numbers, and Toll-Free Numbers
Japan (Kawasaki) International Access Code: 001 Country Code: 81 City Code: 44	Technical Support (Server)	toll-free: 0120-1984-35
	Technical Support Outside of Japan (Server)	81-44-556-4152
	Technical Support (Dimension™ and Inspiron™)	toll-free: 0120-1982-26
	Technical Support Outside of Japan (Dimension and Inspiron)	81-44-520-1435
	Technical Support (Dell Precision™, OptiPlex™, and Latitude™)	toll-free: 0120-1984-33
	Technical Support Outside of Japan (Dell Precision, OptiPlex, and Latitude)	81-44-556-3894
	24-Hour Automated Order Service	044 556-3801
	Customer Care	044 556-4240
	Business Sales Division (Up to 400 employees)	044 556-3494
	Preferred Accounts Division Sales (Over 400 employees)	044 556-3433
	Large Corporate Accounts Sales (Over 3500 employees)	044 556-3440
	Public Sales (Government agencies, educational institutions, and medical institutions)	044 556-3440
	Global Segment Japan	044 556-3469
	Individual User	044 556-1657
	Faxbox Service	044 556-3490
Switchboard	044 556-4300	
Website: support.jp.dell.com		
Korea (Seoul) International Access Code: 001 Country Code: 82 City Code: 2	Technical Support	toll-free: 080-200-3800
	Sales	toll-free: 080-200-3600
	Customer Service (Seoul, Korea)	toll-free: 080-200-3800
	Customer Service (Penang, Malaysia)	604 633 4949
	Fax	2194-6202
Switchboard	2194-6000	

Country (City) International Access Code Country Code City Code	Department Name or Service Area, Website and E-Mail Address	Area Codes, Local Numbers, and Toll-Free Numbers
Latin America	Customer Technical Support (Austin, Texas, U.S.A.)	512 728-4093
	Customer Service (Austin, Texas, U.S.A.)	512 728-3619
	Fax (Technical Support and Customer Service) (Austin, Texas, U.S.A.)	512 728-3883
	Sales (Austin, Texas, U.S.A.)	512 728-4397
	SalesFax (Austin, Texas, U.S.A.)	512 728-4600 or 512 728-3772
Luxembourg International Access Code: 00 Country Code: 352	Technical Support (Brussels, Belgium)	02 481 92 88
	Home/Small Business Sales (Brussels, Belgium)	toll-free: 080016884
	Corporate Sales (Brussels, Belgium)	02 481 91 00
	Customer Care (Brussels, Belgium)	02 481 91 19
	Fax (Brussels, Belgium)	02 481 92 99
	Switchboard (Brussels, Belgium)	02 481 91 00
	Website: support.euro.dell.com E-mail: tech_be@dell.com	
Macau Country Code: 853	Technical Support	toll-free: 0800 582
	Customer Service (Penang, Malaysia)	604 633 4949
	Transaction Sales	toll-free: 0800 581
Malaysia (Penang) International Access Code: 00 Country Code: 60 City Code: 4	Technical Support	toll-free: 1 800 888 298
	Customer Service	04 633 4949
	Transaction Sales	toll-free: 1 800 888 202
	Corporate Sales	toll-free: 1 800 888 213

Country (City) International Access Code Country Code City Code	Department Name or Service Area, Website and E-Mail Address	Area Codes, Local Numbers, and Toll-Free Numbers
Mexico International Access Code: 00 Country Code: 52	Customer Technical Support Sales Customer Service Main	001-877-384-8979 or 001-877-269-3383 50-81-8800 or 01-800-888-3355 001-877-384-8979 or 001-877-269-3383 50-81-8800 or 01-800-888-3355
Netherlands Antilles	General Support	001-800-882-1519
Netherlands (Amsterdam) International Access Code: 00 Country Code: 31 City Code: 20	Technical Support Customer Care Home/Small Business Sales Home/Small Business Sales Fax Corporate Sales Corporate Sales Fax Fax Switchboard Website: support.euro.dell.com E-mail: tech_nl@dell.com	020 581 8838 020 581 8740 toll-free: 0800-0663 020 682 7171 020 581 8818 020 686 8003 020 686 8003 020 581 8818
New Zealand International Access Code: 00 Country Code: 64	Home and Small Business Government and Business Sales Fax	0800 446 255 0800 444 617 0800 441 567 0800 441 566
Nicaragua	General Support	001-800-220-1006

Country (City) International Access Code Country Code City Code	Department Name or Service Area, Website and E-Mail Address	Area Codes, Local Numbers, and Toll-Free Numbers
Norway (Lysaker)	Technical Support	671 16882
International Access Code: 00	Relational Customer Care	671 17514
Country Code: 47	Home/Small Business Customer Care	23162298
	Switchboard	671 16800
	Fax Switchboard	671 16865
	Website: support.euro.dell.com	
	E-mail Support (Portable Computers): nor_nbk_support@dell.com	
	E-mail Support (Desktop Computers): nor_support@dell.com	
	E-mail Support (Servers): Nordic_server_support@dell.com	
Panama	General Support	001-800-507-0962
Peru	General Support	0800-50-669
Poland (Warsaw)	Customer Service Phone	57 95 700
International Access Code: 011	Customer Care	57 95 999
Country Code: 48	Sales	57 95 999
City Code: 22	Customer Service Fax	57 95 806
	Reception Desk Fax	57 95 998
	Switchboard	57 95 999
	Website: support.euro.dell.com	
	E-mail: pl_support@dell.com	
Portugal	Technical Support	800 834 077
International Access Code: 00	Customer Care	800 300 415 or 800 834 075
Country Code: 35	Sales	800 300 410 or 800 300 411 or 800 300 412 or 121 422 07 10
	Fax	121 424 01 12
	E-mail: support.euro.dell.com/es/es/emaildell/	
Puerto Rico	General Support	1-800-805-7545

Country (City) International Access Code Country Code City Code	Department Name or Service Area, Website and E-Mail Address	Area Codes, Local Numbers, and Toll-Free Numbers
St. Lucia	General Support	1-800-882-1521
Singapore (Singapore)	Technical Support	toll-free: 800 6011 051
International Access Code: 005	Customer Service (Penang, Malaysia)	604 633 4949
Country Code: 65	Transaction Sales	toll-free: 800 6011 054
	Corporate Sales	toll-free: 800 6011 053
South Africa (Johannesburg)	Technical Support	011 709 7710
International Access Code: 09/091	Customer Care	011 709 7707
	Sales	011 709 7700
Country Code: 27	Fax	011 706 0495
City Code: 11	Switchboard	011 709 7700
	Website: support.euro.dell.com	
	E-mail: dell_za_support@dell.com	
Southeast Asian and Pacific Countries	Customer Technical Support, Customer Service, and Sales (Penang, Malaysia)	604 633 4810
Spain (Madrid)	Home and Small Business	
International Access Code: 00	Technical Support	902 100 130
Country Code: 34	Customer Care	902 118 540
City Code: 91	Sales	902 118 541
	Switchboard	902 118 541
	Fax	902 118 539
	Website: support.euro.dell.com	
	E-mail: support.euro.dell.com/es/es/emaildell/	
	Corporate	
	Technical Support	902 100 130
	Customer Care	902 118 546
	Switchboard	91 722 92 00
	Fax	91 722 95 83
	Website: support.euro.dell.com	
	E-mail: support.euro.dell.com/es/es/emaildell/	

Country (City) International Access Code Country Code City Code	Department Name or Service Area, Website and E-Mail Address	Area Codes, Local Numbers, and Toll-Free Numbers
Sweden (Upplands Vasby)	Technical Support	08 590 05 199
International Access Code: 00	Relational Customer Care	08 590 05 642
Country Code: 46	Home/Small Business Customer Care	08 587 70 527
City Code: 8	Fax Technical Support	08 590 05 594
	Sales	08 590 05 185
	Website: support.euro.dell.com	
	E-mail: swe_support@dell.com	
	E-mail Support for Latitude and Inspiron: Swe-nbk_kats@dell.com	
	E-mail Support for OptiPlex: Swe_kats@dell.com	
	E-mail Support for Servers: Nordic_server_support@dell.com	
Switzerland (Geneva)	Technical Support (Home and Small Business)	0844 811 411
International Access Code: 00	Technical Support (Corporate)	0844 822 844
Country Code: 41	Customer Care (Home and Small Business)	0848 802 202
City Code: 22	Customer Care (Corporate)	0848 821 721
	Fax	022 799 01 90
	Switchboard	022 799 01 01
	Website: support.euro.dell.com	
	E-mail: swisstech@dell.com	
	E-mail for French Speaking HSB and Corporate Customers: support.euro.dell.com/ch/fr/emaildell/	
Taiwan	Technical Support	toll-free: 0080 60 1255
International Access Code: 002	Technical Support (Servers)	toll-free: 0080 60 1256
Country Code: 886	Transaction Sales	toll-free: 0080 651 228 or 0800 33 556
	Corporate Sales	toll-free: 0080 651 227 or 0800 33 555
Thailand	Technical Support	toll-free: 0880 060 07
International Access Code: 001	Customer Service (Penang, Malaysia)	604 633 4949
Country Code: 66	Sales	toll-free: 0880 060 09

Country (City) International Access Code Country Code City Code	Department Name or Service Area, Website and E-Mail Address	Area Codes, Local Numbers, and Toll-Free Numbers
Trinidad/Tobago	General Support	1-800-805-8035
U.K. (Bracknell) International Access Code: 00 Country Code: 44 City Code: 1344	Technical Support (Corporate/Preferred Accounts/PAD [1000+ employees]) Technical Support (Direct/PAD and general) Global Accounts Customer Care Home and Small Business Customer Care Corporate Customer Care Preferred Accounts (500–5000 employees) Customer Care Central Government Customer Care Local Government & Education Customer Care Health Customer Care Home and Small Business Sales Corporate/Public Sector Sales Website: support.euro.dell.com Customer Care Website: dell.co.uk/lca/customerservices E-mail: dell_direct_support@dell.com	0870 908 0500 0870 908 0800 01344 373 185 or 01344 373 186 0870 906 0010 0870 908 0500 01344 373 196 01344 373 193 01344 373 199 01344 373 194 0870 907 4000 01344 860 456

Country (City) International Access Code Country Code City Code	Department Name or Service Area, Website and E-Mail Address	Area Codes, Local Numbers, and Toll-Free Numbers
U.S.A. (Austin, Texas)	Automated Order-Status System	toll-free: 1-800-433-9014
International Access Code: 011	AutoTech (For portable and desktop computers)	toll-free: 1-800-247-9362
Country Code: 1	Dell Home and Small Business Group (For portable and desktop computers):	
	Customer Technical Support (Return Material Authorization Numbers)	toll-free: 1-800-624-9896
	Customer Technical Support (Home sales purchased via www.dell.com)	toll-free: 1-877-576-3355
	Customer Service (Credit Return Authorization Numbers)	toll-free: 1-800-624-9897
	National Accounts (Computers purchased by established Dell national accounts [have your account number handy] or value-added resellers [VARs]):	
	Customer Service and Technical Support (Return Material Authorization Numbers)	toll-free: 1-800-822-8965
	Public Americas (Computers purchased by governmental agencies [local, state, or federal], medical institutions, or educational institutions):	
	Customer Service and Technical Support (Return Material Authorization Numbers)	toll-free: 1-800-234-1490
	Dell Sales	toll-free: 1-800-289-3355 or toll-free: 1-800-879-3355
	Spare Parts Sales	toll-free: 1-800-357-3355
	Desktop and Portable Fee-Based Technical Support	toll-free: 1-800-433-9005
	Sales (Catalogs)	toll-free: 1-800-426-5150
	Fax	toll-free: 1-800-727-8320
	TechFax	toll-free: 1-800-950-1329
	Dell Services for the Deaf, Hard-of-Hearing, or Speech-Impaired	toll-free: 1-877-DELLTY (1-877-335-5889)
	Switchboard	512 338-4400
	DellNet™ Technical Support	toll-free: 1-877-Dellnet (1-877-335-5638)
US Virgin Islands	General Support	1-877-673-3355
Venezuela	General Support	8001-3605

Returning Items for Warranty Repair or Credit

Prepare all items being returned, whether for repair or credit, as follows:

- 1 Call Dell to obtain an authorization number, and write it clearly and prominently on the outside of the box.
- 2 Include a copy of the invoice and a letter describing the reason for the return.
- 3 Include any accessories that belong with the item(s) being returned (power cables, CDs, guides, and so on) if the return is for credit.
- 4 Pack the equipment to be returned in the original (or equivalent) packing materials.

You are responsible for paying shipping expenses. You are also responsible for insuring any product returned, and you assume the risk of loss during shipment to Dell. Collect-on-delivery packages are not accepted.

Returns that are missing any of the preceding requirements will be refused at our receiving dock and returned to you.

Regulatory Information

Electromagnetic Interference (EMI) is any signal or emission, radiated in free space or conducted along power or signal leads, that endangers the functioning of a radio navigation or other safety service or seriously degrades, obstructs, or repeatedly interrupts a licensed radio communications service. Radio communications services include but are not limited to AM/FM commercial broadcast, television, cellular services, radar, air-traffic control, pager, and Personal Communication Services (PCS). These licensed services, along with unintentional radiators such as digital devices, including computers, contribute to the electromagnetic environment.

Electromagnetic Compatibility (EMC) is the ability of items of electronic equipment to function properly together in the electronic environment. While this computer has been designed and determined to be compliant with regulatory agency limits for EMI, there is no guarantee that interference will not occur in a particular installation. If this equipment does cause interference with radio communications services, which can be determined by turning the equipment off and on, you are encouraged to try to correct the interference by one or more of the following measures:

- Reorient the receiving antenna.
- Relocate the computer with respect to the receiver.
- Move the computer away from the receiver.
- Plug the computer into a different outlet so that the computer and the receiver are on different branch circuits.

If necessary, consult a Dell Technical Support representative or an experienced radio/television technician for additional suggestions.

Dell computers are designed, tested, and classified for their intended electromagnetic environment. These electromagnetic environment classifications generally refer to the following harmonized definitions:

- Class A is typically for business or industrial environments.
- Class B is typically for residential environments.

Information Technology Equipment (ITE), including devices, expansion cards, printers, input/output (I/O) devices, monitors, and so on, that are integrated into or connected to the computer should match the electromagnetic environment classification of the computer.

A Notice About Shielded Signal Cables: Use only shielded cables for connecting devices to any Dell device to reduce the possibility of interference with radio communications services. Using shielded cables ensures that you maintain the appropriate EMC classification for the intended environment. For parallel printers, a cable is available from Dell. If you prefer, you can order a cable from Dell on the World Wide Web at accessories.us.dell.com/sna/category.asp?category_id=4117.

Most Dell computers are classified for Class B environments. However, the inclusion of certain options can change the rating of some configurations to Class A. To determine the electromagnetic classification for your computer or device, refer to the following sections specific for each regulatory agency. Each section provides country-specific EMC/EMI or product safety information.

Additional regulatory information regarding your computer can be found in the *Tell Me How* help file. To access the *Tell Me How* help file, see page 26.

FCC Notices (U.S. Only)

Most Dell computers are classified by the Federal Communications Commission (FCC) as Class B digital devices. To determine which classification applies to your computer, examine all FCC registration labels located on the bottom or back panel of your computer, on card-mounting brackets, and on the cards themselves. If any one of the labels carries a Class A rating, your entire computer is considered to be a Class A digital device. If all labels carry an FCC Class B rating as distinguished by either an FCC ID number or the FCC logo, (FCC), your computer is considered to be a Class B digital device.

Once you have determined your computer's FCC classification, read the appropriate FCC notice. Note that FCC regulations provide that changes or modifications not expressly approved by Dell could void your authority to operate this equipment.

This device complies with Part 15 of the FCC Rules. Operation is subject to the following two conditions:

- This device may not cause harmful interference.
- This device must accept any interference received, including interference that may cause undesired operation.

Class A

This equipment has been tested and found to comply with the limits for a Class A digital device pursuant to Part 15 of the FCC Rules. These limits are designed to provide reasonable protection against harmful interference when the equipment is operated in a commercial environment. This equipment generates, uses, and can radiate radio frequency energy and, if not installed and used in accordance with the manufacturer's instruction manual, may cause harmful interference with radio communications. Operation of this equipment in a residential area is likely to cause harmful interference, in which case you will be required to correct the interference at your own expense.

Class B

This equipment has been tested and found to comply with the limits for a Class B digital device pursuant to Part 15 of the FCC Rules. These limits are designed to provide reasonable protection against harmful interference in a residential installation. This equipment generates, uses, and can radiate radio frequency energy and, if not installed and used in accordance with the manufacturer's instruction manual, may cause interference with radio communications. However, there is no guarantee that interference will not occur in a particular installation. If this equipment does cause harmful interference to radio or television reception, which can be determined by turning the equipment off and on, you are encouraged to try to correct the interference by one or more of the following measures:

- Reorient or relocate the receiving antenna.
- Increase the separation between the equipment and the receiver.
- Connect the equipment into an outlet on a circuit different from that to which the receiver is connected.
- Consult the dealer or an experienced radio/television technician for help.

The following information is provided on the device or devices covered in this document in compliance with FCC regulations:

- Model number: DHS
- Company name:

Dell Computer Corporation
One Dell Way
Round Rock, Texas 78682 USA

NOM Information (Mexico Only)

The following information is provided on the device(s) described in this document in compliance with the requirements of the official Mexican standards (NOM):

Exporter:	Dell Computer Corporation One Dell Way Round Rock, TX 78682
Importer:	Dell Computer de México, S.A. de C.V. Paseo de la Reforma 2620 - 11° Piso Col. Lomas Altas 11950 México, D.F.
Ship to:	Dell Computer de México, S.A. de C.V. al Cuidado de Kuehne & Nagel de México S. de R.I. Avenida Soles No. 55 Col. Peñon de los Baños 15520 México, D.F.
Model number:	DHS
Supply voltage:	115–230 VAC
Frequency:	60–50 Hz
Input current rating:	2.0/1.0 A

Limited Warranties and Return Policy

Dell-branded hardware products purchased in the U.S. or Canada come with either a one-year, two-year, three-year, or four-year (U.S. only) limited warranty. To determine which warranty you purchased, see the Dell invoice that accompanied your computer. The following sections describe these limited warranties, the manufacturer guarantee for Latin America and the Caribbean, and the return policy for the U.S.

One-Year Limited Warranty (U.S. Only)

Dell Computer Corporation ("Dell") manufactures its hardware products from parts and components that are new or equivalent to new in accordance with industry-standard practices. Dell warrants that the hardware products it manufactures will be free from defects in materials and workmanship. The limited warranty term is one year beginning on the date of invoice, as further described in the following text.

Damage due to shipping the products to you is covered under this limited warranty. Otherwise, this limited warranty does not cover damage due to external causes, including accident, abuse, misuse, problems with electrical power, servicing not authorized by Dell, usage not in accordance with product instructions, failure to perform required preventive maintenance, and problems caused by use of parts and components not supplied by Dell.

This limited warranty does not cover any items that are in one or more of the following categories: software; external devices (except as specifically noted); accessories or parts added to a Dell system after the system is shipped from Dell; accessories or parts added to a Dell system through Dell's system integration department; accessories or parts that are not installed in the Dell factory; or Dell Software and Peripherals products. Monitors, keyboards, and mice that are Dell-branded or that are included on Dell's standard price list are covered under this limited warranty; all other monitors, keyboards, and mice (including those sold through the Dell Software and Peripherals program) are not covered.

Dell will repair or replace products covered under this limited warranty that are returned to Dell's facility. To request warranty service, you must contact Dell's Customer Technical Support within the limited warranty period. See "Contacting Dell" on page 84 to find the appropriate contact information for obtaining customer assistance. If warranty service is required, Dell will issue a Return Material Authorization Number. You must ship the products back to Dell in their original or equivalent packaging, prepay shipping charges, and insure the shipment or accept the risk of loss or damage during shipment. Dell will ship the repaired or replacement products to you (freight prepaid) if you use an address in the continental U.S., where applicable. Shipments to other locations will be made freight collect.

NOTE: Before you ship the product(s) to Dell, back up the data on the hard drive(s) and any other storage device(s) in the product(s). Remove any removable media, such as floppy disks, CDs, or PC Cards. Dell does not accept liability for lost data or software.

Dell owns all parts removed from repaired products. Dell uses new and reconditioned parts made by various manufacturers in performing warranty repairs and building replacement products. If Dell repairs or replaces a product, its warranty term is not extended.

THIS LIMITED WARRANTY GIVES YOU SPECIFIC LEGAL RIGHTS, AND YOU MAY ALSO HAVE OTHER RIGHTS, WHICH VARY FROM STATE TO STATE (OR JURISDICTION TO JURISDICTION). DELL'S RESPONSIBILITY FOR MALFUNCTIONS AND DEFECTS IN HARDWARE IS LIMITED TO REPAIR AND REPLACEMENT AS SET FORTH IN THIS LIMITED WARRANTY STATEMENT. ALL EXPRESS AND IMPLIED WARRANTIES FOR THE PRODUCT, INCLUDING BUT NOT LIMITED TO ANY IMPLIED WARRANTIES OF AND CONDITIONS OF MERCHANTABILITY AND FITNESS FOR A PARTICULAR PURPOSE, ARE LIMITED IN DURATION TO THE WARRANTY PERIOD SET FORTH ABOVE AND NO WARRANTIES, WHETHER EXPRESS OR IMPLIED, WILL APPLY AFTER SUCH PERIOD.

SOME STATES (OR JURISDICTIONS) DO NOT ALLOW LIMITATIONS ON HOW LONG AN IMPLIED WARRANTY LASTS, SO THE PRECEDING LIMITATION MAY NOT APPLY TO YOU.

DELL DOES NOT ACCEPT LIABILITY BEYOND THE REMEDIES SET FORTH IN THIS LIMITED WARRANTY STATEMENT OR LIABILITY FOR INCIDENTAL OR CONSEQUENTIAL DAMAGES, INCLUDING WITHOUT LIMITATION ANY LIABILITY FOR PRODUCTS NOT BEING AVAILABLE FOR USE OR FOR LOST DATA OR SOFTWARE.

SOME STATES (OR JURISDICTIONS) DO NOT ALLOW THE EXCLUSION OR LIMITATION OF INCIDENTAL OR CONSEQUENTIAL DAMAGES, SO THE PRECEDING EXCLUSION OR LIMITATION MAY NOT APPLY TO YOU.

These provisions apply to Dell's one-year limited warranty only. For provisions of any service contract covering your system, refer to your invoice or the separate service contract that you will receive.

If Dell elects to exchange a product or portion of a product, the exchange will be made in accordance with Dell's Exchange Policy in effect on the date of the exchange. In any instance in which Dell issues a Return Material Authorization Number, Dell must receive the product(s) for repair prior to the expiration of the warranty period in order for the repair(s) to be covered by the limited warranty.

Two-Year Limited Warranty (U.S. Only)

Dell Computer Corporation ("Dell") manufactures its hardware products from parts and components that are new or equivalent to new in accordance with industry-standard practices. Dell warrants that the hardware products it manufactures will be free from defects in materials and workmanship. The limited warranty term is two years beginning on the date of invoice, as further described in the following section.

Damage due to shipping the products to you is covered under this warranty. Otherwise, this limited warranty does not cover damage due to external causes, including accident, abuse, misuse, problems with electrical power, servicing not authorized by Dell, usage not in accordance with product instructions, failure to perform required preventive maintenance, and problems caused by use of parts and components not supplied by Dell.

This limited warranty does not cover any items that are in one or more of the following categories: software; external devices (except as specifically noted); accessories or parts added to a Dell system after the system is shipped from Dell; accessories or parts added to a Dell system through Dell's system integration department; accessories or parts that are not installed in the Dell factory; or Dell Software and Peripherals products. Monitors, keyboards, and mice that are Dell-branded or that are included on Dell's standard price list are covered under this warranty; all other monitors, keyboards, and mice (including those sold through the Dell Software and Peripherals program) are not covered. Batteries for portable computers are covered only during the initial one-year period of this limited warranty.

Limited Warranty Coverage During Year One

During the one-year period beginning on the invoice date, Dell will repair or replace products covered under this limited warranty that are returned to Dell's facility. To request warranty service, you must contact Dell's Customer Technical Support within the warranty period. See "Contacting Dell" on page 84 to find the appropriate contact information for obtaining customer assistance. If warranty service is required, Dell will issue a Return Material Authorization Number. You must ship the products back to Dell in their original or equivalent packaging, prepay shipping charges, and insure the shipment or accept the risk of loss or damage during shipment. Dell will ship the repaired or replacement products to you freight prepaid if you use an address in the continental U.S., where applicable. Shipments to other locations will be made freight collect.

NOTE: Before you ship the product(s) to Dell, back up the data on the hard drive(s) and any other storage device(s) in the product(s). Remove any removable media, such as floppy disks, CDs, or PC Cards. Dell does not accept liability for lost data or software.

Dell owns all parts removed from repaired products. Dell uses new and reconditioned parts made by various manufacturers in performing warranty repairs and building replacement products. If Dell repairs or replaces a product, its warranty term is not extended.

Limited Warranty Coverage During Year Two

During the second year of this limited warranty, Dell will provide, on an exchange basis and subject to Dell's Exchange Policy in effect on the date of the exchange, replacement parts for the Dell hardware product(s) covered under this limited warranty when a part requires replacement. You must report each instance of hardware failure to Dell's Customer Technical Support in advance to obtain Dell's concurrence that a part should be replaced and to have Dell ship the replacement part. Dell will ship parts (freight prepaid) if you use an address in the continental U.S., where applicable. Shipments to other locations, where applicable, will be made freight collect. Dell will include a prepaid shipping container with each replacement part for your use in returning the replaced part to Dell. Replacement parts are new or reconditioned. Dell may provide replacement parts made by various manufacturers when supplying parts to you. The warranty term for a replacement part is the remainder of the limited warranty term.

You will pay Dell for replacement parts if the replaced part is not returned to Dell. The process for returning replaced parts, and your obligation to pay for replacement parts if you do not return the replaced parts to Dell, will be in accordance with Dell's Exchange Policy in effect on the date of the exchange.

You accept full responsibility for your software and data. Dell is not required to advise or remind you of appropriate backup and other procedures.

General Provisions

THIS LIMITED WARRANTY GIVES YOU SPECIFIC LEGAL RIGHTS, AND YOU MAY ALSO HAVE OTHER RIGHTS, WHICH VARY FROM STATE TO STATE (OR JURISDICTION TO JURISDICTION). DELL'S RESPONSIBILITY FOR MALFUNCTIONS AND DEFECTS IN HARDWARE IS LIMITED TO REPAIR AND REPLACEMENT AS SET FORTH IN THIS LIMITED WARRANTY STATEMENT. ALL EXPRESS AND IMPLIED WARRANTIES FOR THE PRODUCT, INCLUDING BUT NOT LIMITED TO ANY IMPLIED WARRANTIES OF AND CONDITIONS OF MERCHANTABILITY AND FITNESS FOR A PARTICULAR PURPOSE, ARE LIMITED IN DURATION TO THE WARRANTY PERIOD SET FORTH ABOVE AND NO WARRANTIES, WHETHER EXPRESS OR IMPLIED, WILL APPLY AFTER SUCH PERIOD. SOME STATES (OR JURISDICTIONS) DO NOT ALLOW LIMITATIONS ON HOW LONG AN IMPLIED WARRANTY LASTS, SO THE PRECEDING LIMITATION MAY NOT APPLY TO YOU.

DELL DOES NOT ACCEPT LIABILITY BEYOND THE REMEDIES SET FORTH IN THIS LIMITED WARRANTY STATEMENT OR LIABILITY FOR INCIDENTAL OR CONSEQUENTIAL DAMAGES, INCLUDING WITHOUT LIMITATION ANY LIABILITY FOR PRODUCTS NOT BEING AVAILABLE FOR USE OR FOR LOST DATA OR SOFTWARE. SOME STATES (OR JURISDICTIONS) DO NOT ALLOW THE EXCLUSION OR LIMITATION OF INCIDENTAL OR CONSEQUENTIAL DAMAGES, SO THE PRECEDING EXCLUSION OR LIMITATION MAY NOT APPLY TO YOU.

These provisions apply to Dell's two-year limited warranty only. For provisions of any service contract covering your system, refer to your invoice or the separate service contract that you will receive.

If Dell elects to exchange a system or component, the exchange will be made in accordance with Dell's Exchange Policy in effect on the date of the exchange. In any instance in which Dell issues a Return Material Authorization Number, Dell must receive the product(s) for repair prior to the expiration of the warranty period in order for the repair(s) to be covered by the limited warranty.

Three-Year Limited Warranty (U.S. Only)

Dell Computer Corporation ("Dell") manufactures its hardware products from parts and components that are new or equivalent to new in accordance with industry-standard practices. Dell warrants that the hardware products it manufactures will be free from defects in materials and workmanship. The limited warranty term is three years beginning on the date of invoice, as described in the following text.

Damage due to shipping the products to you is covered under this limited warranty. Otherwise, this limited warranty does not cover damage due to external causes, including accident, abuse, misuse, problems with electrical power, servicing not authorized by Dell, usage not in accordance with product instructions, failure to perform required preventive maintenance, and problems caused by use of parts and components not supplied by Dell.

This limited warranty does not cover any items that are in one or more of the following categories: software; external devices (except as specifically noted); accessories or parts added to a Dell system after the system is shipped from Dell; accessories or parts added to a Dell system through Dell's system integration department; accessories or parts that are not installed in the Dell factory; or Dell Software and Peripherals products. Monitors, keyboards, and mice that are Dell-branded or that are included on Dell's standard price list are covered under this limited warranty; all other monitors, keyboards, and mice (including those sold through the Dell Software and Peripherals program) are not covered. Batteries for portable computers are covered only during the initial one-year period of this limited warranty.

Limited Warranty Coverage During Year One

During the one-year period beginning on the invoice date, Dell will repair or replace products covered under this limited warranty that are returned to Dell's facility. To request warranty service, you must contact Dell's Customer Technical Support within the warranty period. See "Contacting Dell" on page 84 to find the appropriate contact information for obtaining customer assistance. If warranty service is required, Dell will issue a Return Material Authorization Number. You must ship the products back to Dell in their original or equivalent packaging, prepay shipping charges, and insure the shipment or accept the risk of loss or damage during shipment. Dell will ship the repaired or replacement products to you freight prepaid if you use an address in the continental U.S., where applicable. Shipments to other locations will be made freight collect.

NOTE: Before you ship the product(s) to Dell, back up the data on the hard drive(s) and any other storage device(s) in the product(s). Remove any removable media, such as floppy disks, CDs, or PC Cards. Dell does not accept liability for lost data or software.

Dell owns all parts removed from repaired products. Dell uses new and reconditioned parts made by various manufacturers in performing warranty repairs and building replacement products. If Dell repairs or replaces a product, its warranty term is not extended.

Limited Warranty Coverage During Years Two and Three

During the second and third years of this limited warranty, Dell will provide, on an exchange basis and subject to Dell's Exchange Policy in effect on the date of the exchange, replacement parts for the Dell hardware product(s) covered under this limited warranty when a part requires replacement. You must report each instance of hardware failure to Dell's Customer Technical Support in advance to obtain Dell's concurrence that a part should be replaced and to have Dell ship the replacement part. Dell will ship parts (freight prepaid) if you use an address in the continental U.S., where applicable. Shipments to other locations will be made freight collect. Dell will include a prepaid shipping container with each replacement part for your use in returning the replaced part to Dell. Replacement parts are new or reconditioned. Dell may provide replacement parts made by various manufacturers when supplying parts to you. The warranty term for a replacement part is the remainder of the limited warranty term.

You will pay Dell for replacement parts if the replaced part is not returned to Dell. The process for returning replaced parts, and your obligation to pay for replacement parts if you do not return the replaced parts to Dell, will be in accordance with Dell's Exchange Policy in effect on the date of the exchange.

You accept full responsibility for your software and data. Dell is not required to advise or remind you of appropriate backup and other procedures.

General Provisions

THIS LIMITED WARRANTY GIVES YOU SPECIFIC LEGAL RIGHTS, AND YOU MAY ALSO HAVE OTHER RIGHTS, WHICH VARY FROM STATE TO STATE (OR JURISDICTION TO JURISDICTION). DELL'S RESPONSIBILITY FOR MALFUNCTIONS AND DEFECTS IN HARDWARE IS LIMITED TO REPAIR AND REPLACEMENT AS SET FORTH IN THIS LIMITED WARRANTY STATEMENT. ALL EXPRESS AND IMPLIED WARRANTIES FOR THE PRODUCT, INCLUDING BUT NOT LIMITED TO ANY IMPLIED WARRANTIES OF AND CONDITIONS OF MERCHANTABILITY AND FITNESS FOR A PARTICULAR PURPOSE, ARE LIMITED IN DURATION TO THE WARRANTY PERIOD SET FORTH ABOVE AND NO WARRANTIES, WHETHER EXPRESS OR IMPLIED, WILL APPLY AFTER SUCH PERIOD.

SOME STATES (OR JURISDICTIONS) DO NOT ALLOW LIMITATIONS ON HOW LONG AN IMPLIED WARRANTY LASTS, SO THE PRECEDING LIMITATION MAY NOT APPLY TO YOU.

DELL DOES NOT ACCEPT LIABILITY BEYOND THE REMEDIES SET FORTH IN THIS LIMITED WARRANTY STATEMENT OR LIABILITY FOR INCIDENTAL OR CONSEQUENTIAL DAMAGES, INCLUDING WITHOUT LIMITATION ANY LIABILITY FOR PRODUCTS NOT BEING AVAILABLE FOR USE OR FOR LOST DATA OR SOFTWARE.

SOME STATES (OR JURISDICTIONS) DO NOT ALLOW THE EXCLUSION OR LIMITATION OF INCIDENTAL OR CONSEQUENTIAL DAMAGES, SO THE PRECEDING EXCLUSION OR LIMITATION MAY NOT APPLY TO YOU.

These provisions apply to Dell's three-year limited warranty only. For provisions of any service contract covering your system, refer to your invoice or the separate service contract that you will receive.

If Dell elects to exchange a system or component, the exchange will be made in accordance with Dell's Exchange Policy in effect on the date of the exchange. In any instance in which Dell issues a Return Material Authorization Number, Dell must receive the product(s) for repair prior to the expiration of the warranty period in order for the repair(s) to be covered by the limited warranty.

Four-Year Limited Warranty (U.S. Only)

Dell Computer Corporation ("Dell") manufactures its hardware products from parts and components that are new or equivalent to new in accordance with industry-standard practices. Dell warrants that the hardware products it manufactures will be free from defects in materials and workmanship. The limited warranty term is four years beginning on the date of invoice, as further described in the following text.

Damage due to shipping the products to you is covered under this limited warranty. Otherwise, this limited warranty does not cover damage due to external causes, including accident, abuse, misuse, problems with electrical power, servicing not authorized by Dell, usage not in accordance with product instructions, failure to perform required preventive maintenance, and problems caused by use of parts and components not supplied by Dell.

This limited warranty does not cover any items that are in one or more of the following categories: software; external devices (except as specifically noted); accessories or parts added to a Dell system after the system is shipped from Dell; accessories or parts added to a Dell system through Dell's system integration department; accessories or parts that are not installed in the Dell factory; or Dell Software and Peripherals products. Monitors, keyboards, and mice that are Dell-branded or that are included on Dell's standard price list are covered under this limited warranty; all other monitors, keyboards, and mice (including those sold through the Dell Software and Peripherals program) are not covered. Batteries for portable computers are covered only during the initial one-year period of this limited warranty.

Limited Warranty Coverage During Year One

During the one-year period beginning on the invoice date, Dell will repair or replace products covered under this limited warranty that are returned to Dell's facility. To request limited warranty service, you must contact Dell's Customer Technical Support within the limited warranty period. See "Contacting Dell" on page 84 to find the appropriate contact information for obtaining customer assistance. If limited warranty service is required, Dell will issue a Return Material Authorization Number. You must ship the products back to Dell in their original or equivalent packaging, prepay shipping charges, and insure the shipment or accept the risk of loss or damage during shipment. Dell will ship the repaired or replacement products to you freight prepaid if you use an address in the continental U.S., where applicable. Shipments to other locations will be made freight collect.

NOTE: Before you ship the product(s) to Dell, back up the data on the hard drive(s) and any other storage device(s) in the product(s). Remove any removable media, such as floppy disks, CDs, or PC Cards. Dell does not accept liability for lost data or software.

Dell owns all parts removed from repaired products. Dell uses new and reconditioned parts made by various manufacturers in performing limited warranty repairs and building replacement products. If Dell repairs or replaces a product, its limited warranty term is not extended.

Limited Warranty Coverage During Years Two, Three, and Four

During the second, third, and fourth years of this limited warranty, Dell will provide, on an exchange basis and subject to Dell's Exchange Policy in effect on the date of the exchange, replacement parts for the Dell hardware product(s) covered under this limited warranty when a part requires replacement. You must report each instance of hardware failure to Dell's Customer Technical Support in advance to obtain Dell's concurrence that a part should be replaced and to have Dell ship the replacement part. Dell will ship parts (freight prepaid) if you use an address in the continental U.S., where applicable. Shipments to other locations will be made freight collect. Dell will include a prepaid shipping container with each replacement part for your use in returning the replaced part to Dell. Replacement parts are new or reconditioned. Dell may provide replacement parts made by various manufacturers when supplying parts to you. The limited warranty term for a replacement part is the remainder of the limited warranty term.

You will pay Dell for replacement parts when the replaced part is not returned to Dell. The process for returning replaced parts, and your obligation to pay for replacement parts if you do not return the replaced parts to Dell, will be in accordance with Dell's Exchange Policy in effect on the date of the exchange.

You accept full responsibility for your software and data. Dell is not required to advise or remind you of appropriate backup and other procedures.

General Provisions

THIS LIMITED WARRANTY GIVES YOU SPECIFIC LEGAL RIGHTS, AND YOU MAY ALSO HAVE OTHER RIGHTS, WHICH VARY FROM STATE TO STATE (OR JURISDICTION TO JURISDICTION). DELL'S RESPONSIBILITY FOR MALFUNCTIONS AND DEFECTS IN HARDWARE IS LIMITED TO REPAIR AND REPLACEMENT AS SET FORTH IN THIS LIMITED WARRANTY STATEMENT. ALL EXPRESS AND IMPLIED WARRANTIES FOR THE PRODUCT, INCLUDING BUT NOT LIMITED TO ANY IMPLIED WARRANTIES OF AND CONDITIONS OF MERCHANTABILITY AND FITNESS FOR A PARTICULAR PURPOSE, ARE LIMITED IN DURATION TO THE LIMITED WARRANTY PERIOD SET FORTH ABOVE AND NO WARRANTIES, WHETHER EXPRESS OR IMPLIED, WILL APPLY AFTER SUCH PERIOD. SOME STATES (OR JURISDICTIONS) DO NOT ALLOW LIMITATIONS ON HOW LONG AN IMPLIED WARRANTY LASTS, SO THE PRECEDING LIMITATION MAY NOT APPLY TO YOU.

DELL DOES NOT ACCEPT LIABILITY BEYOND THE REMEDIES SET FORTH IN THIS LIMITED WARRANTY STATEMENT OR LIABILITY FOR INCIDENTAL OR CONSEQUENTIAL DAMAGES, INCLUDING WITHOUT LIMITATION ANY LIABILITY FOR PRODUCTS NOT BEING AVAILABLE FOR USE OR FOR LOST DATA OR SOFTWARE. SOME STATES (OR JURISDICTIONS) DO NOT ALLOW THE EXCLUSION OR LIMITATION OF INCIDENTAL OR CONSEQUENTIAL DAMAGES, SO THE PRECEDING EXCLUSION OR LIMITATION MAY NOT APPLY TO YOU.

If Dell elects to exchange a system or component, the exchange will be made accordance with Dell's Exchange Policy in effect on the date of the exchange. In any instance in which Dell issues a Return Material Authorization Number, Dell must receive the product(s) for repair prior to the expiration of the limited warranty period in order for the repairs to be covered by the limited warranty.

These provisions apply to Dell's four-year limited warranty only. For provisions of any on-site service contract covering your system, refer to the separate on-site service contract that you will receive.

One-Year Limited Warranty (Canada Only)

Dell Computer Corporation ("Dell") manufactures its hardware products from parts and components that are new or equivalent to new in accordance with industry-standard practices. Dell warrants that the hardware products it manufactures will be free from defects in materials and workmanship. The limited warranty term is one year beginning on the date of invoice, as further described in the following text.

Damage due to shipping the products to you is covered under this limited warranty. Otherwise, this limited warranty does not cover damage due to external causes, including accident, abuse, misuse, problems with electrical power, servicing not authorized by Dell, usage not in accordance with product instructions, failure to perform required preventive maintenance, and problems caused by use of parts and components not supplied by Dell.

This limited warranty does not cover any items that are in one or more of the following categories: software; external devices (except as specifically noted); accessories or parts added to a Dell system after the system is shipped from Dell; accessories or parts added to a Dell system through Dell's system integration department; accessories or parts that are not installed in the Dell factory; or Dell Software and Peripherals products. Monitors, keyboards, and mice that are Dell-branded or that are included on Dell's standard price list are covered under this limited warranty; all other monitors, keyboards, and mice (including those sold through the Dell Software and Peripherals program) are not covered.

Dell will repair or replace products covered under this limited warranty that are returned to Dell's facility. To request warranty service, you must contact Dell's Customer Technical Support within the warranty period. See "Contacting Dell" on page 84 to find the appropriate contact information for obtaining customer assistance. If warranty service is required, Dell will issue a Return Material Authorization Number. You must ship the products back to Dell in their original or equivalent packaging, prepay shipping charges, and insure the shipment or accept the risk of loss or damage during shipment. Dell will ship the repaired or replacement products to you (freight prepaid) if you use an address in Canada, where applicable. Shipments to other locations will be made freight collect.

NOTE: Before you ship the product(s) to Dell, back up the data on the hard drive(s) and any other storage device(s) in the product(s). Remove any removable media, such as floppy disks, CDs, or PC Cards. Dell does not accept liability for lost data or software.

Dell owns all parts removed from repaired products. Dell uses new and reconditioned parts made by various manufacturers in performing warranty repairs and building replacement products. If Dell repairs or replaces a product, its warranty term is not extended.

DELL MAKES NO EXPRESS WARRANTIES OR CONDITIONS BEYOND THOSE STATED IN THIS LIMITED WARRANTY STATEMENT. DELL DISCLAIMS ALL OTHER WARRANTIES AND CONDITIONS, EXPRESS OR IMPLIED, INCLUDING WITHOUT LIMITATION IMPLIED WARRANTIES AND CONDITIONS OF MERCHANTABILITY AND FITNESS FOR A PARTICULAR PURPOSE. SOME STATES (OR JURISDICTIONS) DO NOT ALLOW LIMITATIONS ON IMPLIED WARRANTIES OR CONDITIONS, SO THIS LIMITATION MAY NOT APPLY TO YOU.

DELL'S RESPONSIBILITY FOR MALFUNCTIONS AND DEFECTS IN HARDWARE IS LIMITED TO REPAIR AND REPLACEMENT AS SET FORTH IN THIS LIMITED WARRANTY STATEMENT. THESE WARRANTIES GIVE YOU SPECIFIC LEGAL RIGHTS, AND YOU MAY ALSO HAVE OTHER RIGHTS, WHICH VARY FROM STATE TO STATE (OR JURISDICTION TO JURISDICTION).

DELL DOES NOT ACCEPT LIABILITY BEYOND THE REMEDIES SET FORTH IN THIS LIMITED WARRANTY STATEMENT OR LIABILITY FOR INCIDENTAL OR CONSEQUENTIAL DAMAGES, INCLUDING WITHOUT LIMITATION ANY LIABILITY FOR PRODUCTS NOT BEING AVAILABLE FOR USE OR FOR LOST DATA OR SOFTWARE.

SOME STATES (OR JURISDICTIONS) DO NOT ALLOW THE EXCLUSION OR LIMITATION OF INCIDENTAL, INDIRECT, SPECIAL, PUNITIVE, OR CONSEQUENTIAL DAMAGES, SO THE PRECEDING EXCLUSION OR LIMITATION MAY NOT APPLY TO YOU.

These provisions apply to Dell's one-year limited warranty only. For provisions of any service contract covering your system, refer to your invoice or the separate service contract that you will receive.

If Dell elects to exchange a product or portion of a product, the exchange will be made in accordance with Dell's Exchange Policy in effect on the date of the exchange. In any instance in which Dell issues a Return Material Authorization Number, Dell must receive the product(s) for repair prior to the expiration of the warranty period in order for the repair(s) to be covered by the limited warranty.

Two-Year Limited Warranty (Canada Only)

Dell Computer Corporation ("Dell") manufactures its hardware products from parts and components that are new or equivalent to new in accordance with industry-standard practices. Dell warrants that the hardware products it manufactures will be free from defects in materials and workmanship. The warranty term is two years beginning on the date of invoice, as described in the following text.

Damage due to shipping the products to you is covered under this limited warranty. Otherwise, this limited warranty does not cover damage due to external causes, including accident, abuse, misuse, problems with electrical power, servicing not authorized by Dell, usage not in accordance with product instructions, failure to perform required preventive maintenance, and problems caused by use of parts and components not supplied by Dell.

This limited warranty does not cover any items that are in one or more of the following categories: software; external devices (except as specifically noted); accessories or parts added to a Dell system after the system is shipped from Dell; accessories or parts added to a Dell system through Dell's system integration department; accessories or parts that are not installed in the Dell factory; or Dell Software and Peripherals products. Monitors, keyboards, and mice that are Dell-branded or that are included on Dell's standard price list are covered under this limited warranty; all other monitors, keyboards, and mice (including those sold through the Dell Software and Peripherals program) are not covered. Batteries for portable computers are covered only during the initial one-year period of this limited warranty.

Limited Warranty Coverage During Year One

During the one-year period beginning on the invoice date, Dell will repair or replace products covered under this limited warranty that are returned to Dell's facility. To request warranty service, you must contact Dell's Customer Technical Support within the warranty period. See "Contacting Dell" on page 84 to find the appropriate contact information for obtaining customer assistance. If warranty service is required, Dell will issue a Return Material Authorization Number. You must ship the products back to Dell in their original or equivalent packaging, prepay shipping charges, and insure the shipment or accept the risk of loss or damage during shipment. Dell will ship the repaired or replacement products to you freight prepaid if you use an address in Canada, where applicable. Shipments to other locations will be made freight collect.

NOTE: Before you ship the product(s) to Dell, back up the data on the hard drive(s) and any other storage device(s) in the product(s). Remove any removable media, such as floppy disks, CDs, or PC Cards. Dell does not accept liability for lost data or software.

Dell owns all parts removed from repaired products. Dell uses new and reconditioned parts made by various manufacturers in performing warranty repairs and building replacement products. If Dell repairs or replaces a product, its warranty term is not extended.

Limited Warranty Coverage During Year Two

During the second year of this limited warranty, Dell will provide, on an exchange basis and subject to Dell's Exchange Policy in effect on the date of the exchange, replacement parts for the Dell hardware product(s) covered under this limited warranty when a part requires replacement. You must report each instance of hardware failure to Dell's Customer Technical Support in advance to obtain Dell's concurrence that a part should be replaced and to have Dell ship the replacement part. Dell will ship parts (freight prepaid) if you use an address in Canada, where applicable. Shipments to other locations will be made freight collect. Dell will include a prepaid shipping container with each replacement part for your use in returning the replaced part to Dell. Replacement parts are new or reconditioned. Dell may provide replacement parts made by various manufacturers when supplying parts to you. The warranty term for a replacement part is the remainder of the limited warranty term.

You will pay Dell for replacement parts if the replaced part is not returned to Dell. The process for returning replaced parts, and your obligation to pay for replacement parts if you do not return the replaced parts to Dell, will be in accordance with Dell's Exchange Policy in effect on the date of the exchange.

You accept full responsibility for your software and data. Dell is not required to advise or remind you of appropriate backup and other procedures.

General Provisions

DELL MAKES NO EXPRESS WARRANTIES OR CONDITIONS BEYOND THOSE STATED IN THIS LIMITED WARRANTY STATEMENT. DELL DISCLAIMS ALL OTHER WARRANTIES AND CONDITIONS, EXPRESS OR IMPLIED, INCLUDING WITHOUT LIMITATION IMPLIED WARRANTIES AND CONDITIONS OF MERCHANTABILITY AND FITNESS FOR A PARTICULAR PURPOSE. SOME STATES (OR JURISDICTIONS) DO NOT ALLOW LIMITATIONS ON IMPLIED WARRANTIES OR CONDITIONS, SO THIS LIMITATION MAY NOT APPLY TO YOU.

DELL'S RESPONSIBILITY FOR MALFUNCTIONS AND DEFECTS IN HARDWARE IS LIMITED TO REPAIR AND REPLACEMENT AS SET FORTH IN THIS LIMITED WARRANTY STATEMENT. THESE WARRANTIES GIVE YOU SPECIFIC LEGAL RIGHTS, AND YOU MAY ALSO HAVE OTHER RIGHTS, WHICH VARY FROM STATE TO STATE (OR JURISDICTION TO JURISDICTION).

DELL DOES NOT ACCEPT LIABILITY BEYOND THE REMEDIES SET FORTH IN THIS LIMITED WARRANTY STATEMENT OR LIABILITY FOR INCIDENTAL OR CONSEQUENTIAL DAMAGES, INCLUDING WITHOUT LIMITATION ANY LIABILITY FOR PRODUCTS NOT BEING AVAILABLE FOR USE OR FOR LOST DATA OR SOFTWARE.

SOME STATES (OR JURISDICTIONS) DO NOT ALLOW THE EXCLUSION OR LIMITATION OF INCIDENTAL, INDIRECT, SPECIAL, PUNITIVE, OR CONSEQUENTIAL DAMAGES, SO THE PRECEDING EXCLUSION OR LIMITATION MAY NOT APPLY TO YOU.

These provisions apply to Dell's two-year limited warranty only. For provisions of any service contract covering your system, refer to your invoice or the separate service contract that you will receive.

If Dell elects to exchange a system or component, the exchange will be made in accordance with Dell's Exchange Policy in effect on the date of the exchange. In any instance in which Dell issues a Return Material Authorization Number, Dell must receive the product(s) for repair prior to the expiration of the warranty period in order for the repair(s) to be covered by the limited warranty.

Three-Year Limited Warranty (Canada Only)

Dell Computer Corporation ("Dell") manufactures its hardware products from parts and components that are new or equivalent to new in accordance with industry-standard practices. Dell warrants that the hardware products it manufactures will be free from defects in materials and workmanship. The warranty term is three years beginning on the date of invoice, as described in the following text.

Damage due to shipping the products to you is covered under this limited warranty. Otherwise, this limited warranty does not cover damage due to external causes, including accident, abuse, misuse, problems with electrical power, servicing not authorized by Dell, usage not in accordance with product instructions, failure to perform required preventive maintenance, and problems caused by use of parts and components not supplied by Dell.

This limited warranty does not cover any items that are in one or more of the following categories: software; external devices (except as specifically noted); accessories or parts added to a Dell system after the system is shipped from Dell; accessories or parts added to a Dell system through Dell's system integration department; accessories or parts that are not installed in the Dell factory; or Dell Software and Peripherals products. Monitors, keyboards, and mice that are Dell-branded or that are included on Dell's standard price list are covered under this limited warranty; all other monitors, keyboards, and mice (including those sold through the Dell Software and Peripherals program) are not covered. Batteries for portable computers are covered only during the initial one-year period of this limited warranty.

Limited Warranty Coverage During Year One

During the one-year period beginning on the invoice date, Dell will repair or replace products covered under this limited warranty that are returned to Dell's facility. To request warranty service, you must contact Dell's Customer Technical Support within the warranty period. To request warranty service, you must contact Dell's Customer Technical Support within the warranty period. See "Contacting Dell" on page 84 to find the appropriate contact information for obtaining customer assistance. If warranty service is required, Dell will issue a Return Material Authorization Number. You must ship the products back to Dell in their original or equivalent packaging, prepay shipping charges, and insure the shipment or accept the risk of loss or damage during shipment. Dell will ship the repaired or replacement products to you freight prepaid if you use an address in Canada, where applicable. Shipments to other locations will be made freight collect.

NOTE: Before you ship the product(s) to Dell, back up the data on the hard drive(s) and any other storage device(s) in the product(s). Remove any removable media, such as floppy disks, CDs, or PC Cards. Dell does not accept liability for lost data or software.

Dell owns all parts removed from repaired products. Dell uses new and reconditioned parts made by various manufacturers in performing warranty repairs and building replacement products. If Dell repairs or replaces a product, its warranty term is not extended.

Limited Warranty Coverage During Years Two and Three

During the second and third years of this limited warranty, Dell will provide, on an exchange basis and subject to Dell's Exchange Policy in effect on the date of the exchange, replacement parts for the Dell hardware product(s) covered under this limited warranty when a part requires replacement. You must report each instance of hardware failure to Dell's Customer Technical Support in advance to obtain Dell's concurrence that a part should be replaced and to have Dell ship the replacement part. Dell will ship parts (freight prepaid) if you use an address in Canada, where applicable. Shipments to other locations will be made freight collect. Dell will include a prepaid shipping container with each replacement part for your use in returning the replaced part to Dell. Replacement parts are new or reconditioned. Dell may provide replacement parts made by various manufacturers when supplying parts to you. The warranty term for a replacement part is the remainder of the limited warranty term.

You will pay Dell for replacement parts if the replaced part is not returned to Dell. The process for returning replaced parts, and your obligation to pay for replacement parts if you do not return the replaced parts to Dell, will be in accordance with Dell's Exchange Policy in effect on the date of the exchange.

You accept full responsibility for your software and data. Dell is not required to advise or remind you of appropriate backup and other procedures.

General Provisions

DELL MAKES NO EXPRESS WARRANTIES OR CONDITIONS BEYOND THOSE STATED IN THIS LIMITED WARRANTY STATEMENT. DELL DISCLAIMS ALL OTHER WARRANTIES AND CONDITIONS, EXPRESS OR IMPLIED, INCLUDING WITHOUT LIMITATION IMPLIED WARRANTIES AND CONDITIONS OF MERCHANTABILITY AND FITNESS FOR A PARTICULAR PURPOSE. SOME STATES (OR JURISDICTIONS) DO NOT ALLOW LIMITATIONS ON IMPLIED WARRANTIES OR CONDITIONS, SO THIS LIMITATION MAY NOT APPLY TO YOU.

DELL'S RESPONSIBILITY FOR MALFUNCTIONS AND DEFECTS IN HARDWARE IS LIMITED TO REPAIR AND REPLACEMENT AS SET FORTH IN THIS LIMITED WARRANTY STATEMENT. THESE WARRANTIES GIVE YOU SPECIFIC LEGAL RIGHTS, AND YOU MAY ALSO HAVE OTHER RIGHTS, WHICH VARY FROM STATE TO STATE (OR JURISDICTION TO JURISDICTION).

DELL DOES NOT ACCEPT LIABILITY BEYOND THE REMEDIES SET FORTH IN THIS LIMITED WARRANTY STATEMENT OR LIABILITY FOR INCIDENTAL OR CONSEQUENTIAL DAMAGES, INCLUDING WITHOUT LIMITATION ANY LIABILITY FOR PRODUCTS NOT BEING AVAILABLE FOR USE OR FOR LOST DATA OR SOFTWARE.

SOME STATES (OR JURISDICTIONS) DO NOT ALLOW THE EXCLUSION OR LIMITATION OF INCIDENTAL, INDIRECT, SPECIAL, PUNITIVE, OR CONSEQUENTIAL DAMAGES, SO THE PRECEDING EXCLUSION OR LIMITATION MAY NOT APPLY TO YOU.

These provisions apply to Dell's three-year limited warranty only. For provisions of any service contract covering your system, refer to your invoice or the separate service contract that you will receive.

If Dell elects to exchange a system or component, the exchange will be made in accordance with Dell's Exchange Policy in effect on the date of the exchange. In any instance in which Dell issues a Return Material Authorization Number, Dell must receive the product(s) for repair prior to the expiration of the warranty period in order for the repair(s) to be covered by the limited warranty.

"Total Satisfaction" Return Policy (U.S. Only)

If you are an end-user customer who bought new products directly from a Dell company, you may return them to Dell within 30 days of the date of invoice for a refund or credit of the product purchase price. If you are an end-user customer who bought reconditioned or refurbished products from a Dell company, you may return them to Dell within 14 days of the date of invoice for a refund or credit of the product purchase price. In either case, the refund or credit will not include any shipping and handling charges shown on your invoice. If you are an organization that bought the products under a written agreement with Dell, the agreement may contain different terms for the return of products than specified by this policy.

To return products, you must contact Dell Customer Service to receive a Credit Return Authorization Number. See "Contacting Dell" on page 84 to find the appropriate contact information for obtaining customer assistance. To expedite the processing of your refund or credit, Dell expects you to return the products to Dell in their original packaging within five days of the date that Dell issues the Credit Return Authorization Number. You must also prepay shipping charges and insure the shipment or accept the risk of loss or damage during shipment. You may return software for refund or credit only if the sealed package containing the floppy disk(s) or CD(s) is unopened. Returned products must be in as-new condition, and all of the manuals, floppy disk(s), CD(s), power cables, and other items included with a product must be returned with it. For customers who want to return, for refund or credit only, either applications software or an operating system that has been installed by Dell, the whole system must be returned, along with any media and documentation that may have been included in the original shipment.

This "Total Satisfaction" Return Policy does not apply to Dell Software and Peripherals products, which may be returned under Dell Software and Peripherals's then-current return policy. The "Total Satisfaction" Return Policy also does not apply to Dell | EMC storage products.

One-Year End-User Manufacturer Guarantee (Latin America and the Caribbean Only)

Guarantee

Dell Computer Corporation ("Dell") warrants to the end user in accordance with the following provisions that its branded hardware products, purchased by the end user from a Dell company or an authorized Dell distributor in Latin America or the Caribbean, will be free from defects in materials, workmanship, and design affecting normal use, for a period of one year from the original purchase date. Products for which proper claims are made will, at Dell's option, be repaired or replaced at Dell's expense. Dell owns all parts removed from repaired products. Dell uses new and reconditioned parts made by various manufacturers in performing repairs and building replacement products.

Exclusions

This Guarantee does not apply to defects resulting from: improper or inadequate installation, use, or maintenance; actions or modifications by unauthorized third parties or the end user; accidental or willful damage; or normal wear and tear.

Making a Claim

Claims must be made in Latin America or the Caribbean by contacting the Dell point of sale within the guarantee period. The end user must always supply proof of purchase, indicating name and address of the seller, date of purchase, model and serial number, name and address of the customer, and details of symptoms and configuration at the time of malfunction, including peripherals and software used. Otherwise, Dell may refuse the guarantee claim. Upon diagnosis of a warranted defect, Dell will make arrangements and pay for ground freight and insurance to and from Dell's repair/replacement center. The end user must ensure that the defective product is available for collection properly packed in original or equally protective packaging together with the details listed above and the return number provided to the end user by Dell.

Limitation and Statutory Rights

Dell makes no other warranty, guarantee or like statement other than as explicitly stated above, and this Guarantee is given in place of all other guarantees whatsoever, to the fullest extent permitted by law. In the absence of applicable legislation, this Guarantee will be the end user's sole and exclusive remedy against Dell or any of its affiliates, and neither Dell nor any of its affiliates shall be liable for loss of profit or contracts, or any other indirect or consequential loss arising from negligence, breach of contract, or howsoever.

This Guarantee does not impair or affect mandatory statutory rights of the end user against and/or any rights resulting from other contracts concluded by the end user with Dell and/or any other seller.

Dell World Trade LP

One Dell Way, Round Rock, TX 78682, USA

Dell Computadores do Brasil Ltda (CNPJ No. 72.381.189/0001-10)/

Dell Commercial do Brasil Ltda (CNPJ No. 03 405 822/0001-40)

Avenida Industrial Belgraf, 400

92990-000 - Eldorado do Sul – RS - Brasil

Dell Computer de Chile Ltda

Coyancura 2283, Piso 3- Of.302,

Providencia, Santiago - Chile

Dell Computer de Colombia Corporation
Carrera 7 #115-33 Oficina 603
Bogota, Colombia

Dell Computer de Mexico SA de CV
Paseo de la Reforma 2620 - 11° Piso
Col. Lomas Altas
11950 México, D.F.

Index

A

audio. *See* sound

B

battery
disposal, 10
replacing, 81

BIOS, 78

C

cards
adding, 66
connectors, 65

CD drive
fixing problems, 28

CD-RW drive
fixing problems, 29

Check Disk, 29

computer
back view, 60
closing cover, 72
error messages, 31, 33
front door, 60
front view, 60
internal parts, 64
opening cover, 62
specifications, 74
turning off, 22

conflicts
resolving software and
hardware
incompatibilities, 54

contact numbers, 84

cover
closing, 72
opening, 62

D

Dell support policy, 83

display. *See* monitor

drivers
reinstalling, 53

drives
fixing problems, 27

DVD drive
fixing problems, 29

E

e-mail
fixing problems, 30

error messages
start-up, 31, 33

F

FCC notices, 99, 101

Files and Settings Transfer
Wizard, 20

finding solutions, 24

fixing problems
drive, 27
e-mail, 30
Internet connection, 30
modem, 30
network, 38
power, 39
printer, 41
scanner, 42
sound and speakers, 43
start-up error messages, 31, 33
video and monitor, 44

floppy drive
fixing problems, 27

front door, 60

H

hard drive
fixing problems, 29

help file
accessing, 26

I

- Internet
 - fixing problems, 30
- IRQ conflicts, 54

M

- memory
 - adding, 70
 - connectors, 65
- messages
 - start-up, 31, 33
- modem
 - fixing problems, 30
- monitor
 - fixing problems, 44
- motherboard. *See* system board

N

- network
 - fixing problems, 38
 - setting up, 21
- Network Setup Wizard, 21

O

- operating system
 - reinstallation
 - Windows XP, 55

P

- password
 - clearing system setup, 80
- power
 - fixing problems, 39
 - turning off, 22
- printer
 - connecting, 18
 - fixing problems, 41
 - reinstalling driver, 19
 - setting up, 18
 - troubleshooting, 41

R

- RAM. *See* memory
- regulatory notices, 101
- reinstalling
 - drivers, 53
 - Windows XP, 55
- ResourceCD, 53
- return policy, 125

S

- safety instructions, 7
- screen. *See* monitor
- settings
 - system setup program, 78
- shutdown, 22
- software
 - reinstalling software, 53

- sound
 - adjusting volume, 43
 - fixing problems, 43
- speaker
 - adjusting volume, 43
 - fixing problems, 43
- specifications, 74
- system board, 65
- System Restore, 50, 55
- system setup program, 78

T

- technical assistance
 - telephone numbers and addresses, 84
 - warranty repair or credit, 99
- Tell Me How help file
 - accessing, 26
- troubleshooting, 24
- turning off the computer, 22

V

- video
 - fixing problems, 44
- video memory
 - connector, 65
- volume
 - adjusting, 43

W

warranty information, 104

Windows XP

device driver rollback, 53

Help, 26

reinstalling, 55

scanner, 42

shutdown, 22

